



Newfoundland and Labrador Hydro
Hydro Place, 500 Columbus Drive
P.O. Box 12400, St. John's, NL
Canada A1B 4K7
t. 709.737.1400 | f. 709.737.1800
nlhydro.com

April 25, 2022

Board of Commissioners of Public Utilities
Prince Charles Building
120 Torbay Road, P.O. Box 21040
St. John's, NL A1A 5B2

Attention: Ms. Cheryl Blundon
Director of Corporate Services & Board Secretary

Dear Ms. Blundon:

Re: Transmission System and Terminal Station Asset Management Execution Report

In its correspondence dated October 13, 2016,¹ the Board of Commissioners of Public Utilities required Newfoundland and Labrador Hydro ("Hydro") file annual reports on transmission system and terminal station asset management execution, including the status of completion of activities in relation to the annual plan and the following year's plan.

Attached please find Hydro's annual report on transmission system and terminal station asset management. The report includes the completion status of activities in relation to the 2021 annual work plan and information relating to Hydro's 2022 planned activities.

Should you have any questions, please contact the undersigned.

Yours truly,

NEWFOUNDLAND AND LABRADOR HYDRO

Shirley A. Walsh
Senior Legal Counsel, Regulatory
SAW/kd

Encl.

ecc:

Board of Commissioners of Public Utilities
Jacqui H. Glynn
Maureen P. Green, Q.C.
PUB Official Email

Praxair Canada Inc.
Sheryl E. Nisenbaum
Peter Strong

Teck Resources Limited
Shawn Kinsella

¹ Board of Commissioners of Public Utilities, "Investigation and Hearing into Supply Issues and Power Outages on the Island Interconnected System – Directions further to the Board's Phase One Report," letter, October 13, 2016.

Ms. C. Blundon
Public Utilities Board

2

Consumer Advocate

Dennis M. Browne, QC, Browne Fitzgerald Morgan & Avis
Stephen F. Fitzgerald, Browne Fitzgerald Morgan & Avis
Sarah G. Fitzgerald, Browne Fitzgerald Morgan & Avis
Bernice Bailey, Browne Fitzgerald Morgan & Avis
Bernard M. Coffey, QC

Newfoundland Power Inc.

Dominic J. Foley
Lindsay S.A. Hollett
Regulatory Email

Island Industrial Customer Group

Paul L. Coxworthy, Stewart McKelvey
Denis J. Fleming, Cox & Palmer
Dean A. Porter, Poole Althouse



Transmission System and Terminal Station Asset Management Execution Report

April 25, 2022

A report to the Board of Commissioners of Public Utilities



Contents

1.0	Introduction	1
2.0	Terminal Stations Asset Management	2
2.1	Asset Criticality and Spares	2
3.0	Transmission Line Asset Management	3
3.1	Wood Pole and Steel Structure Line Management Programs	3
3.2	Helicopter Patrols	4
3.3	Ground Patrols	4
3.4	Infrared Inspections	4
3.5	Wood Pole Treatment	4
3.6	Right-of-Way Maintenance	4
3.7	Asset Criticality and Spares	5
4.0	Status of Planned 2021 Transmission System and Terminal Station Activities	5
4.1	Transmission System	5
4.2	Terminal Stations	8
4.3	Status of 2021 Terminal Station and Transmission Line Capital Projects	10
5.0	Planned 2022 Transmission System and Terminal Station Activities	11
5.1	Transmission System	11
5.2	Terminal Stations	14

List of Appendices

Appendix A: Details of Terminal Station Preventive Maintenance Activities

Appendix B: 2021 Terminal Station and Transmission Line Project Status

List of Attachments

Attachment 1: Terminal Station Asset Management Overview

1.0 Introduction

On October 13, 2016, the Board of Commissioners of Public Utilities requested that Newfoundland and Labrador Hydro (“Hydro”) provide an annual report on Hydro’s transmission system and terminal station asset management execution, including the status of the completion of activities in relation to the Annual Work Plan (“AWP”) and information relating to the current year’s planned activities.¹

Transmission system and terminal station assets provide the means by which generated electricity is delivered to high-voltage customers and the distribution system that serves the remaining customers. Hydro maintains 4,432 km of transmission lines and 69 terminal stations for the Island and Labrador Interconnected Systems, composed of numerous types of assets. Through the application of asset management activities during the life cycle of these assets, Hydro’s asset management personnel utilize a balanced approach to maintain the reliability of the electrical system while managing costs. Hydro’s asset management activities include:

- Refurbishment or replacement of existing assets as required;
- Execution of preventative maintenance (“PM”) and corrective maintenance (“CM”) activities to support reliable operations;
- Asset assessments to monitor asset health; and
- Installation of new assets to support system growth.

These activities are conducted within an asset management system by personnel in the Long-Term Asset Planning (“LTAP”), Short-Term Planning and Scheduling, and Work Execution functions within Hydro.

This report provides:

- Background on transmission system and terminal station equipment and asset management practices;
- Completion status of 2021 AWP maintenance activities and capital transmission system and terminal station projects; and

¹ Board of Commissioners of Public Utilities, “Investigation and Hearing into Supply Issues and Power Outages on the Island Interconnected System – Directions further to the Board’s Phase One Report,” letter, October 13, 2016.

- 1 • Planned 2022 AWP maintenance activities and capital transmission and terminal station
2 projects.

3 Hydro has developed its 2022 AWP in consideration of the lessons learned during the COVID-19
4 pandemic and continues to closely monitor supply chain and execution risk.

5 **2.0 Terminal Stations Asset Management**

6 Hydro has 69 terminal stations on the Island and Labrador Interconnected Systems, with some having
7 assets dating back to the late 1960s. These stations contain electrical equipment such as transformers,
8 circuit breakers, instrument transformers, disconnect switches, arresters, and associated protection and
9 control relays and equipment required to protect, control, and operate Hydro's electrical system.

10 Terminal stations play a critical role in the transmission and distribution of electricity. They act as
11 transition points within the transmission system and interface points with the lower voltage distribution
12 and generation systems.

13 Appendix A outlines Hydro's PM program for the various major asset classes within terminal stations.

14 Attachment 1 provides information regarding Hydro's asset management philosophies and replacement
15 and refurbishment criteria. This overview document is updated as required to reflect changes to Hydro's
16 asset management approach as it evolves and improves.

17 **2.1 Asset Criticality and Spares**

18 Hydro has developed a terminal station asset criticality ranking for selected asset classes based on
19 factors such as available mitigation (e.g., parallel transformers), environmental impact, customer
20 impact, likelihood of breakdown, and cost of repairs. This is considered in prioritizing maintenance and
21 capital work. Hydro uses these factors as well as other equipment-specific factors to establish asset
22 criticality rankings for power transformers, circuit breakers, battery banks and chargers, and disconnect
23 switches. In 2022, Hydro will continue the development of asset criticality rankings for terminal stations
24 as a whole.

25 In 2022, Hydro plans to continue and complete the procurement of spares for power transformer tap
26 changers, Wabush Terminal Station synchronous condensers, and protection and control relays and
27 continue with the procurement of spares for power transformer bushings. Hydro reviews its spare

1 terminal station equipment on a routine basis and establishes plans to achieve the appropriate level of
2 spares based on the outcome of those reviews.

3 **3.0 Transmission Line Asset Management**

4 Hydro owns approximately 648 km of 69 kV, 1,538 km of 138 kV, and 2,246 km of 230 kV transmission
5 lines as part of the Island and Labrador Interconnected Systems, for a total line length of approximately
6 4,432 km. Hydro also owns approximately 30 km of 46 kV sub-transmission lines in Labrador West.

7 Hydro's 69 kV class lines are of wood pole construction and the 138 kV class lines are primarily
8 comprised of wood pole and aluminum lattice structures. The 230 kV class lines are a combination of
9 wood pole and steel lattice construction. Over half of these assets were constructed in the 1960s and
10 early 1970s.

11 Transmission lines are a set of conductors supported by structures that carry electrical power from
12 generation plants to terminal stations and link terminal stations together, allowing for the transmission
13 of electricity across the bulk electrical system. A transmission line consists of structures, conductors,
14 insulators, grounding system, and rights-of-way.

15 The primary subcomponents of a steel structure are the legs, cross members, and grillage foundations
16 which are typically fabricated from structural angle steel. These subcomponents are hot-dip galvanized
17 to ensure extended life. A typical lattice steel structure can last in excess of 70 years.

18 The primary subcomponents of a wood pole structure are the poles, crossarms, and cross braces. These
19 subcomponents are treated with preservatives to ensure extended life. A typical treated wood pole can
20 last in excess of 60 years. Typically, treated crossarms and cross braces can last in excess of 30 years.

21 **3.1 Wood Pole and Steel Structure Line Management Programs**

22 Wood Pole and Steel Structure Line Management Programs are the primary means by which Hydro
23 maintains and refurbishes its transmission lines. These cyclical programs include structure-climbing
24 inspections, wood pole Resistograph® readings and shell thickness measurements, and visual
25 inspections of conductors, guying, and foundations. LTAP personnel establish condition-based
26 assessments to identify and prioritize capital work and CM activities so as to extend line life expectancy.
27 The condition-based data collected is also used to determine when a total line replacement is required.

1 As component replacement quantities increase beyond the budgetary framework of the respective line
2 management programs, separate capital projects are placed into the long-term plan for line upgrades.

3 **3.2 Helicopter Patrols**

4 Helicopter patrols are carried out twice a year on transmission lines.² These patrols conduct visual
5 inspections of the transmission line from the air and look for visible defects and right-of-way
6 deficiencies, such as danger trees. Hydro captures video on all helicopter patrols, which allows for
7 further assessment after completion of the patrol. All deficiencies are documented and scheduled for
8 corrective work.

9 **3.3 Ground Patrols**

10 Ground patrols are generally carried out as part of the Wood Pole and Steel Structure Line Management
11 Programs. Lines exposed to high-loading conditions have annual ground patrols which conduct visual
12 inspection from the ground to identify, assess, and prioritize deficiencies to a transmission line and its
13 right-of-way. Identified deficiencies are documented and scheduled for corrective work.

14 **3.4 Infrared Inspections**

15 Hydro completes infrared scanning of connections on dead end structures on all transmission lines. All
16 deficiencies are documented and scheduled for corrective work.

17 **3.5 Wood Pole Treatment**

18 Preservative treatment is added to the poles to extend their service life through the Wood Pole Line
19 Management (“WPLM”) Program.

20 **3.6 Right-of-Way Maintenance**

21 A transmission line runs along a corridor typically referred to as a right-of-way. The width of the right-of-
22 way depends on the voltage class of the transmission line, or if several lines run through the same
23 corridor. Uncontrolled vegetation growth may eventually lead to outages due to conductor contact or
24 travel access restrictions on the right-of-way due to thick brush. During transmission line inspections,
25 tree height and vegetation growth are noted in addition to areas that need repairs, such as washouts.
26 The work to control vegetation is prioritized based on condition. Hydro utilizes a combination of cutting

² As part of Hydro’s Labrador East Reliability Plan, helicopter patrols are completed monthly on Labrador East transmission lines during the winter operating season.

1 and spraying to control vegetation growth on its rights-of-way. Hydro performs vegetation control on
2 approximately 10% of its rights-of-way per year with approximately 60% of the annual program
3 involving vegetation cutting and the remaining 40% of the vegetation sprayed with herbicide.

4 3.7 Asset Criticality and Spares

5 Hydro has developed a transmission line asset criticality ranking based on the health of asset, available
6 mitigation (e.g., backup generation), environmental impact, customer impact, likelihood of breakdown,
7 and cost of repairs. These factors are considered in prioritizing maintenance and capital work. Rankings
8 have been established for all transmission lines using this approach.

9 Hydro reviews its spare transmission materials on a routine basis. From these reviews, action is taken or
10 plans are established to achieve appropriate levels of spares.

11 4.0 Status of Planned 2021 Transmission System and 12 Terminal Station Activities

13 The year-end 2021 completion status of the AWP and Winter Readiness (“WR”) activities for
14 transmission system and terminal station facilities on the Island and Labrador Interconnected System is
15 summarized in the following sections.

16 4.1 Transmission System

17 As shown in Figure 1 to Figure 4, Hydro completed 100% of its planned 2021 transmission system AWP
18 and WR activities.

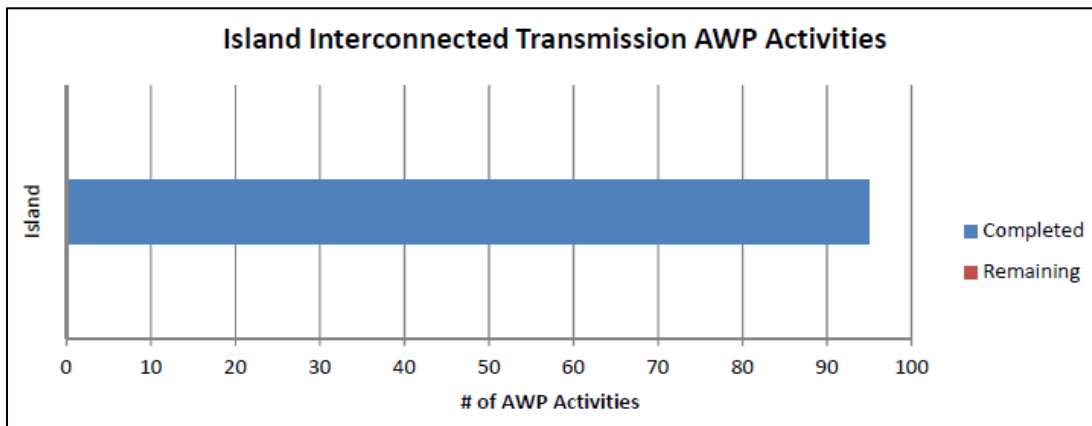

Figure 1: 2021 Transmission System AWP Activities for the Island Interconnected System (December 31, 2021)

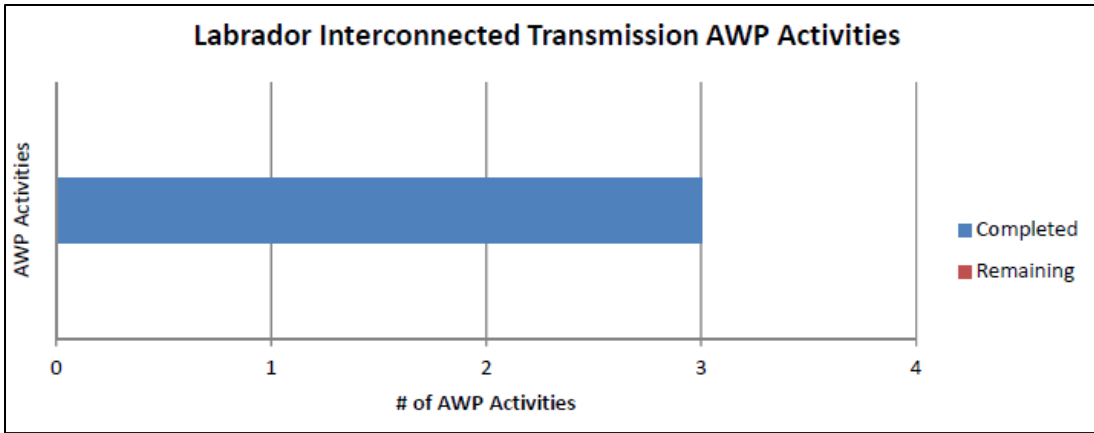

Figure 2: 2021 Transmission System AWP Activities for the Labrador Interconnected System (December 31, 2021)

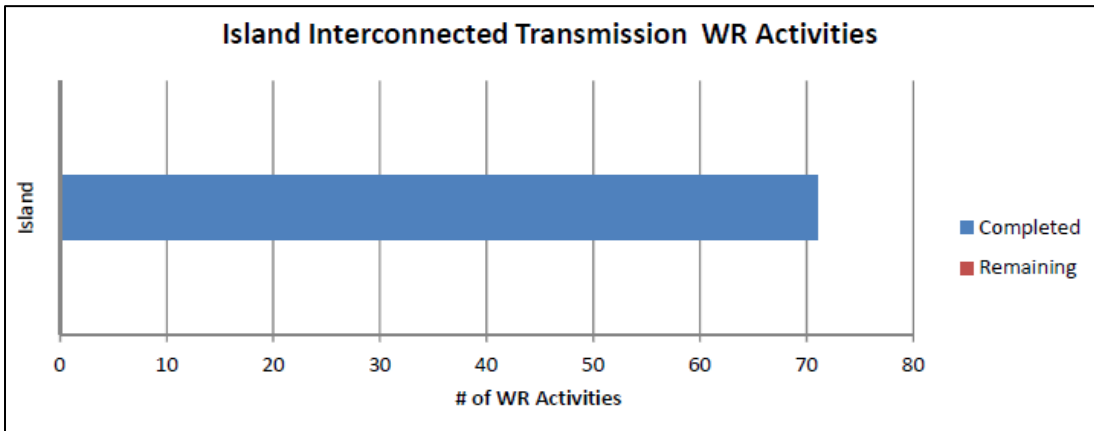

Figure 3: 2021 Transmission System WR Activities for the Island Interconnected System (December 31, 2021)

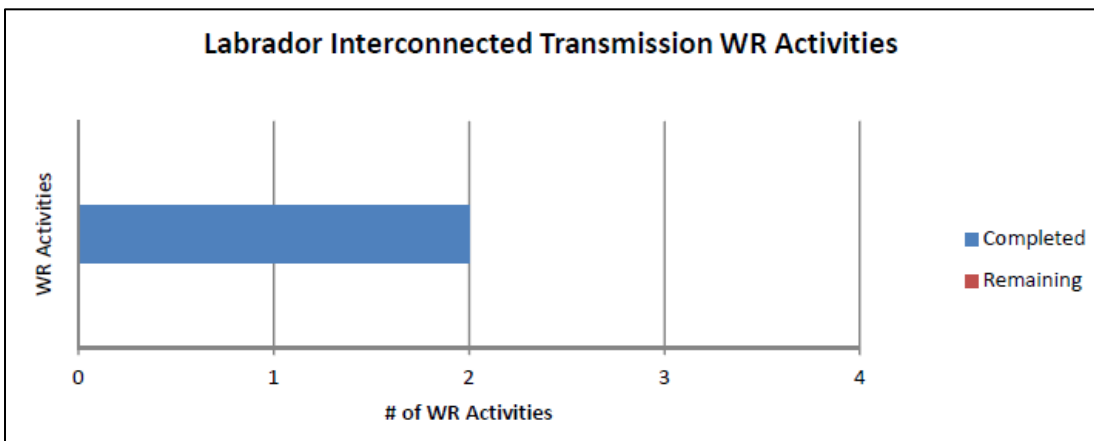

Figure 4: 2021 Transmission System WR Activities for the Labrador Interconnected System (December 31, 2021)

- 1 The following is a summary of the transmission system activities completed in 2021:
- 2 • Muskrat Falls to Happy Valley Interconnection Transmission Line L1303 was placed into service³;
- 3 • Completion of the following WPLM inspections and refurbishments; and
- 4 ○ Inspection on TL210, TL219, TL220, TL222, TL233, TL234, TL241, TL259 and TL260; and
- 5 ○ Refurbishment on TL209, TL219, TL222, TL226, TL227, TL232, TL233, TL243, TL250, TL254,
- 6 and TL257.
- 7 • Completion of Steel Line Inspection Program inspections, as referenced in Table 1.

Table 1: 2021 Steel Line Climbing/Ground Inspections Completed

Line #	Climbing Inspection (Structures)	Ground Patrol (Structures)
TL202	139-156, 245-262	35-68, 210-246
TL204	81-90, 231-247	1-22, 205-235
TL205	168-188	42-83
TL206	139-156, 250-270	35-68, 212-249
TL207	16-30	1-30
TL208	26-46	1-46
TL211	113-126	28-55
TL212	148-221	148-221
TL214	92-137, 275-355	56-110
TL217	26-50	52-103
TL228	109-126, 218-225	38-74, 250-271
TL231	22-32, 248-265	22-32, 211-245
TL236	48-52	1-56
TL237	73-90	37-72
TL242	50-56	15-28
TL247	261-297, 431-445	75-149, 411-445
TL248	128-147	38-75
TL265	16-20	1-50
TL268	16-20	1-50
L23	71-84, 213-226, 356-369, 499-512	
L24	71-84, 213-226, 356-369, 499-512	

³ Work remains to be completed under the Muskrat Falls to Happy Valley Interconnection to add additional transformation capacity at the Happy Valley Terminal Station, planned for completion in summer 2022.

1 **4.2 Terminal Stations**

2 As shown in Figure 5 to Figure 8, Hydro completed 96% and 99% of its planned 2021 terminal station
3 Island Interconnected System and Labrador Interconnected System AWP activities respectively, and 100% of its
4 planned 2021 terminal station WR activities as of December 31, 2021. The incomplete activities were
5 assessed and mitigated to ensure there was no significant risk to reliable operation for the winter
6 season.

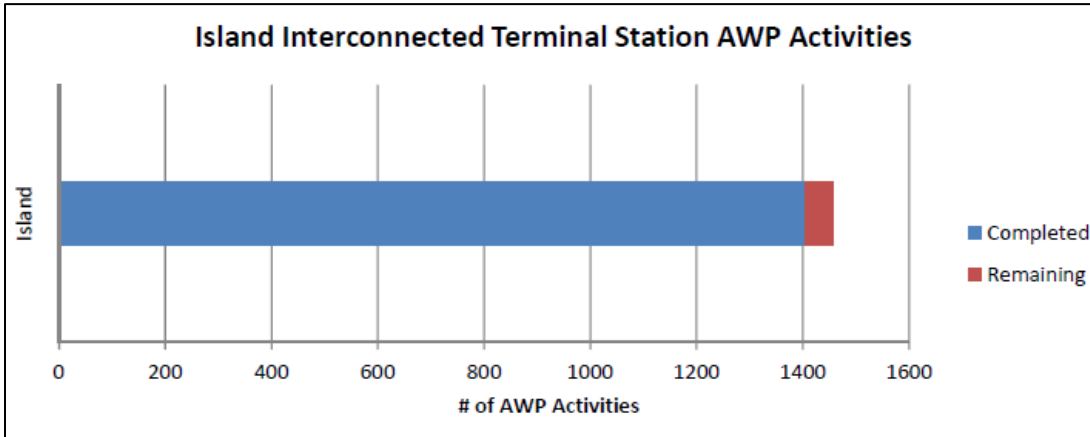

Figure 5: 2021 Terminal Station AWP Activities for the Island Interconnected System (December 31, 2021)

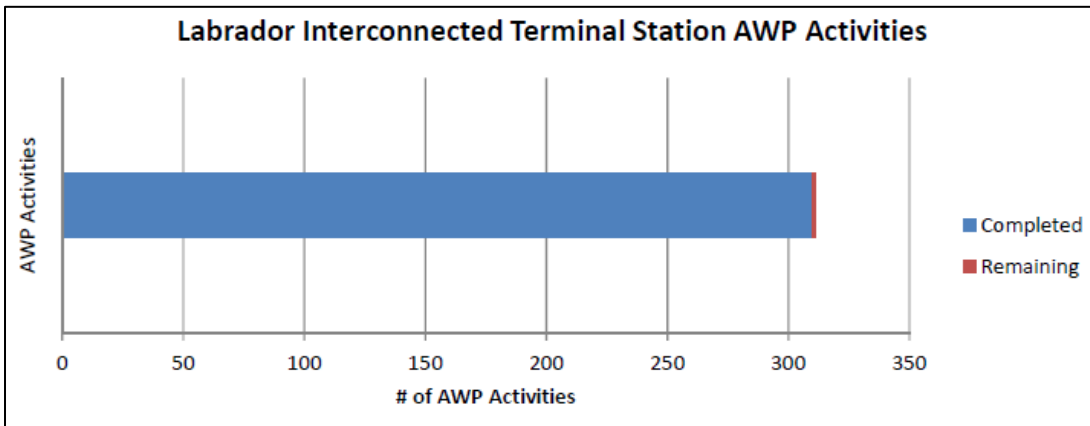

Figure 6: 2021 Terminal Station AWP Activities for the Labrador Interconnected System (December 31, 2021)

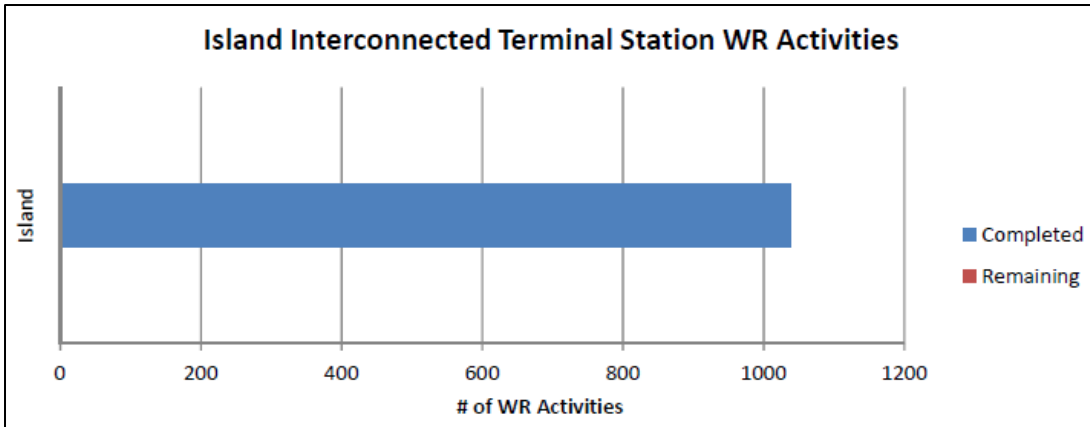

Figure 7: 2021 Terminal Station WR Activities for the Island Interconnected System (December 31, 2021)

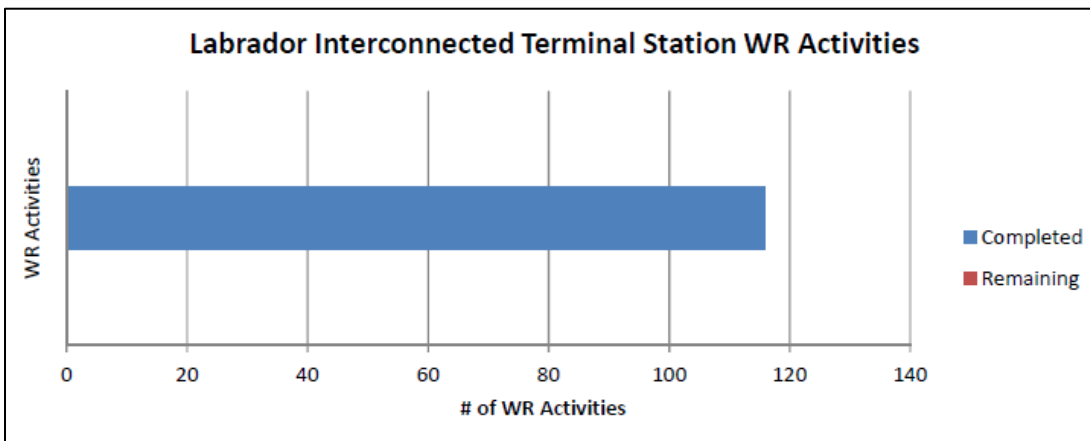

Figure 8: 2021 Terminal Station WR Activities for the Labrador Interconnected System (December 31, 2021)

- 1 The following is a summary of the terminal station activities completed in 2021:
- 2
 - Completed 25 six-year breaker PM procedures;
- 3
 - Operated all 69 kV and above circuit breakers once throughout the year;
- 4
 - Completed 18 trip from protection breaker maintenance procedures;
- 5
 - Completed 28 six-year power transformer maintenance procedures and 23 six-year power
- 6
 - transformer Doble maintenance procedures;
- 7
 - Completed Oil Quality and Dissolved Gas Analysis Program for power transformers and tap
- 8
 - changers;

- 1 • Completed 126 disconnect switch PM procedures;
- 2 • Completed six-year protection and control maintenance procedures at 13 stations;
- 3 • Completed 131 six-year instrument transformer maintenance procedures;
- 4 • Completed 127 six-year instrument transformer Doble maintenance procedures;
- 5 • Completed infrared scans at all terminal stations;
- 6 • Completed annual battery maintenance at all terminal stations;
- 7 • Replaced three battery banks;
- 8 • Replaced 14 circuit breakers, including six air blast circuit breakers and six oil circuit breakers;
- 9 • Power Transformers: completed one radiator replacement, three tap changer overhauls, and 28
- 10 bushing replacements on five transformers; installed five online gas monitors;
- 11 • Replaced four surge arrestors;
- 12 • Replaced ten disconnect switches;
- 13 • Replaced 18 instrument transformers;
- 14 • Replaced protective relays for three transformer protection schemes and two bus protection
- 15 schemes; and
- 16 • Replaced 63 post insulators.

4.3 Status of 2021 Terminal Station and Transmission Line Capital Projects

Appendix B identifies the capital projects that included planned construction completion in 2021 for assets in terminal stations and on transmission lines, and indicates the completion status of each. Table 2 summarizes the completion status of these projects by asset category.

Table 2: Status of Capital Projects with Planned Construction Completion in 2021

Asset Category	Partially Complete/			Total
	Complete	Deferred	Incomplete	
Transmission Lines	0	2	0	2
Terminal Stations	3	7	3	13
Total	3	9	3	15

1 Where elements of work in the transmission lines and terminal station asset categories have been
2 deferred to 2022, Hydro assessed the risk and determined that these deferred activities would not
3 significantly impact the reliability of the Island and Labrador Interconnected Systems for winter 2021–
4 2022. Further project details are provided in Appendix B.

5 **5.0 Planned 2022 Transmission System and Terminal Station** 6 **Activities**

7 Hydro has established its AWP scope of work for 2022, including identification of WR activities. The
8 charts below provide an overview of work progress and a summary of key activities is also provided for
9 each area.

10 **5.1 Transmission System**

11 As shown in Figure 9 to Figure 12, Hydro has completed approximately 38% of its planned 2022
12 transmission system AWP activities and approximately 39% of its 2022 WR activities for the Island
13 Interconnected System as of April 15, 2022. For the Labrador Interconnected System, 25% of AWP
14 activities are complete and no WR activities are complete as of April 15, 2022.

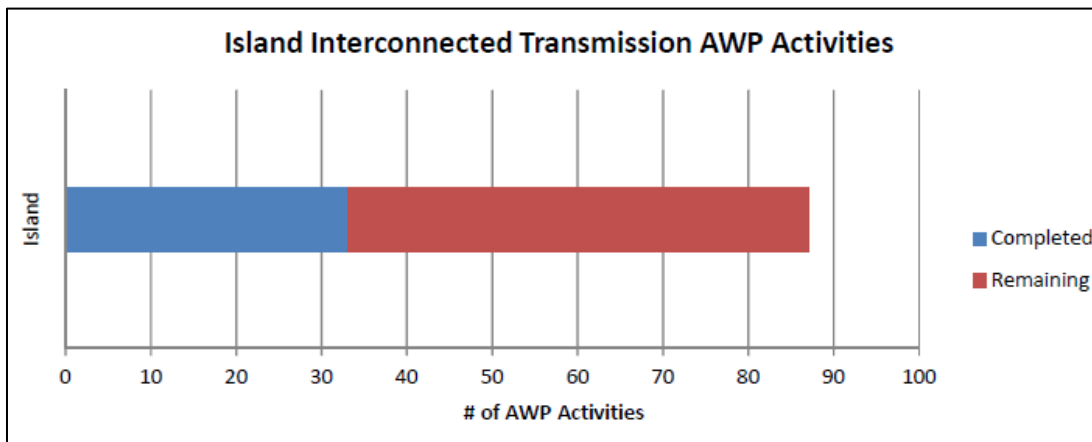

Figure 9: 2022 Transmission System AWP Activities for the Island Interconnected System (April 15, 2022)

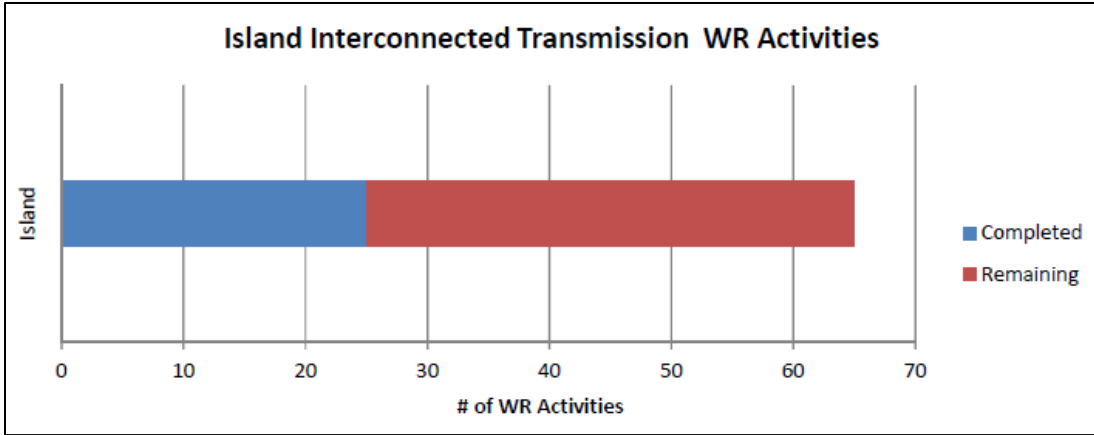

Figure 10: 2022 Transmission System WR Activities for the Island Interconnected System (April 15, 2022)

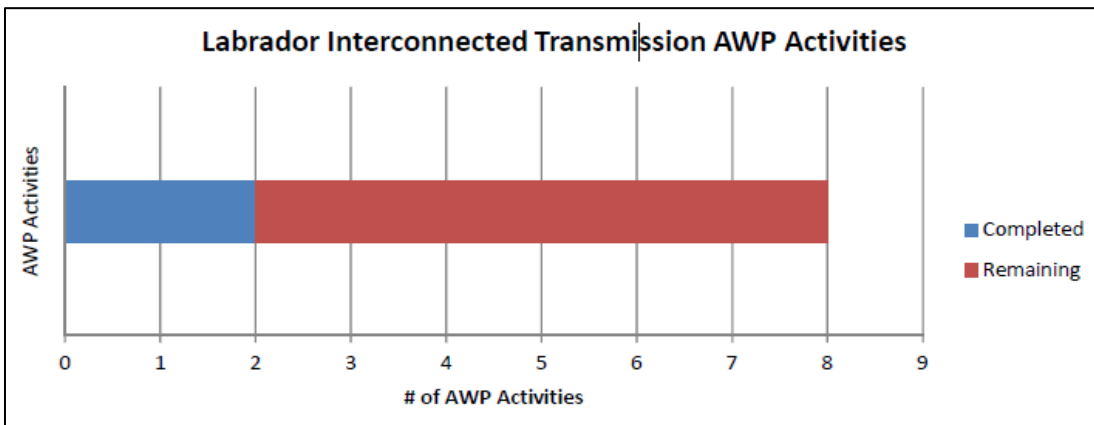

Figure 11: 2022 Transmission System AWP Activities for the Labrador Interconnected System (April 15, 2022)

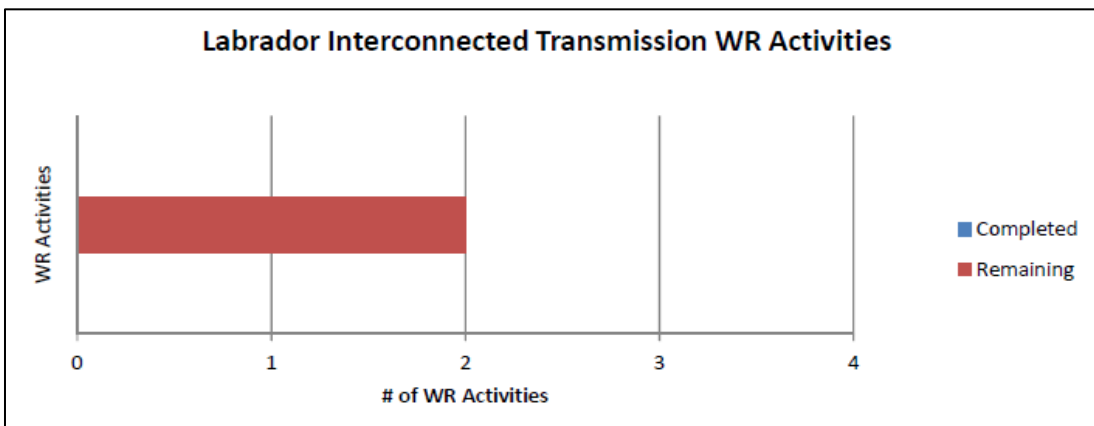

Figure 12: 2022 Transmission System WR Activities for the Labrador Interconnected System (April 15, 2022)

- 1 The following is a summary of the transmission system work plan activities scheduled for 2022:
- 2 • Commence decommissioning of Transmission Line L1301, Churchill Falls to Muskrat Falls;
- 3 • Commence construction of Transmission Line TL271, Star Lake to Marathon Gold’s Terminal
- 4 Station;
- 5 • WPLM inspections and refurbishments:
- 6 ○ Inspect: TL201, TL210, TL221, TL233, TL234, TL256, TL259, TL260; and
- 7 ○ Refurbish: TL201, TL215, TL219, TL222, TL234, TL241, TL250, TL259 and TL260.
- 8 • Steel Line Inspection Program inspections, as referenced in Table 3.

Table 3: 2022 Steel Line Climbing/Ground Inspections

Line #	Climbing Inspection (Structures)	Ground Patrol (Structures)
TL202	157-172, 263-280	69-102, 247-282
TL204	91-101, 248-264	23-44, 174-204
TL205	189-208	84-125
TL206	157-172, 271-287	69-102, 250-287
TL207	1-15	1-30
TL208	1-25	1-46
TL211	127-140	56-83
TL212	74-147	74-147
TL214	229-274, 275-355	111-166
TL217	51-75	104-155
TL228	127-144, 226-233	75-112, 189-219
TL231	33-43, 266-278	64-84, 176-210
TL236	53-56	1-56
TL237	91-108	73-108
TL242	29-35	29-42
TL247	298-334, 417-430	225-299, 372-410
TL248	148-166	76-112
TL265	21-25	n/a
TL268	21-25	n/a
L23	34-44, 67-77, 85-98, 227-240, 370-383, 513-526	
L24	34-44, 67-77, 85-98, 227-240, 370-383, 513-526	

1 **5.2 Terminal Stations**

2 As shown in Figure 13 and Figure 14, Hydro has completed approximately 27% of its planned 2022
3 terminal station AWP activities and approximately 33% of its 2022 WR activities for the Island
4 Interconnected System as of April 15, 2022. As shown in Figure 15 and Figure 16, Hydro has completed
5 approximately 14% of its planned 2022 terminal station AWP activities and approximately 9% of its 2022
6 WR activities for the Labrador Interconnected System as of April 15, 2022.

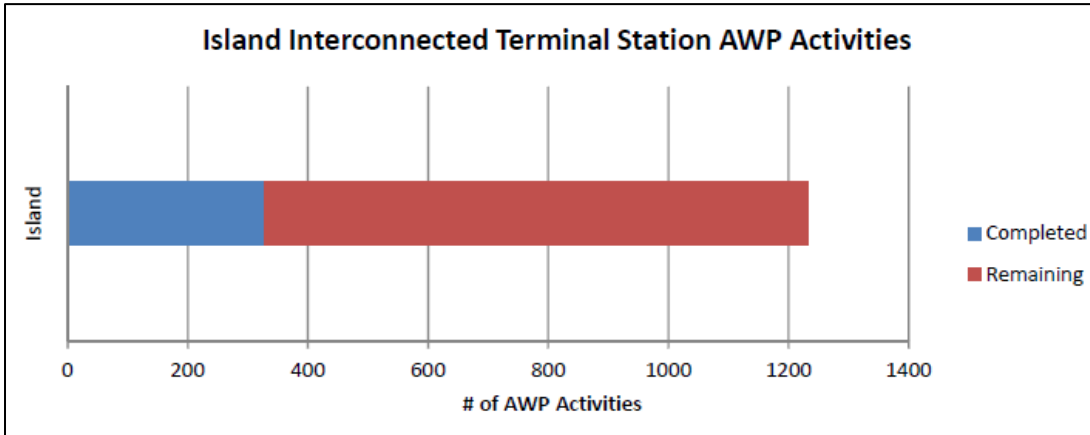

Figure 13: 2022 Terminal Station AWP Activities for the Island Interconnected System (April 15, 2022)

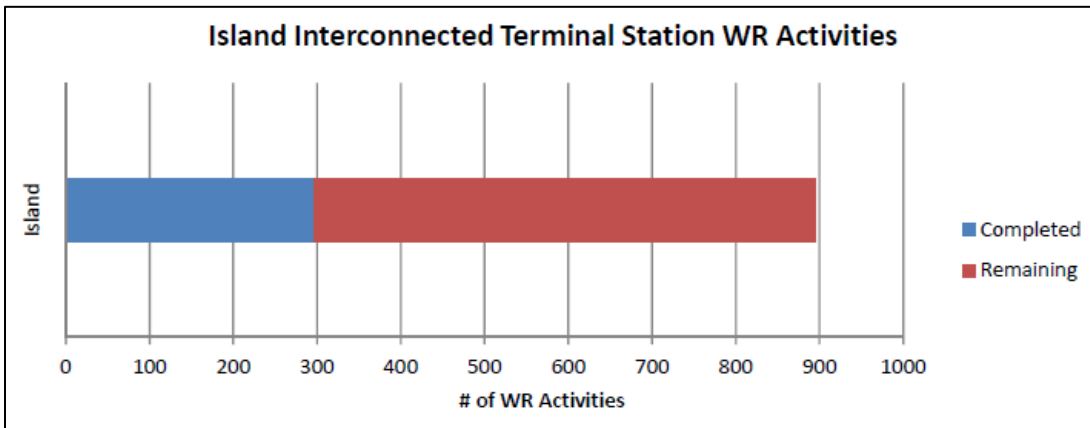

Figure 14: 2022 Terminal Station WR Activities for the Island Interconnected System (April 15, 2022)

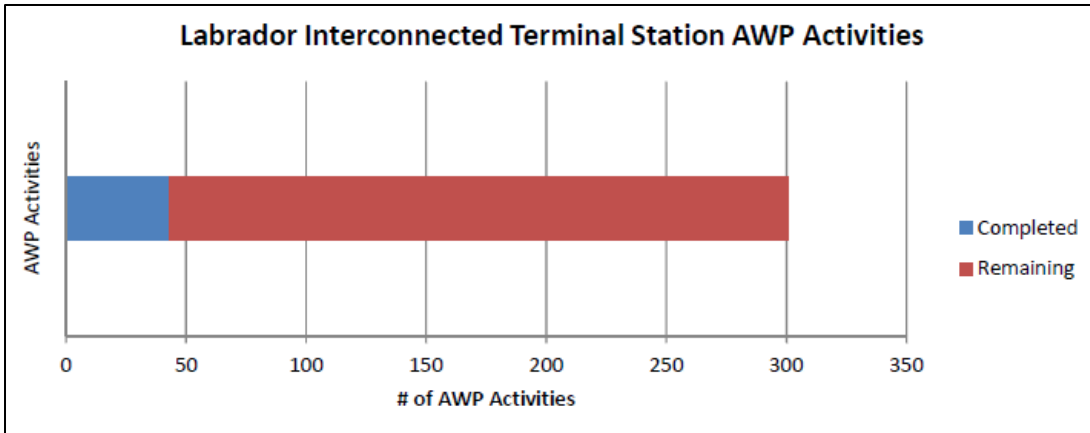

Figure 15: 2022 Terminal Station AWP Activities for the Labrador Interconnected System (April 15, 2022)

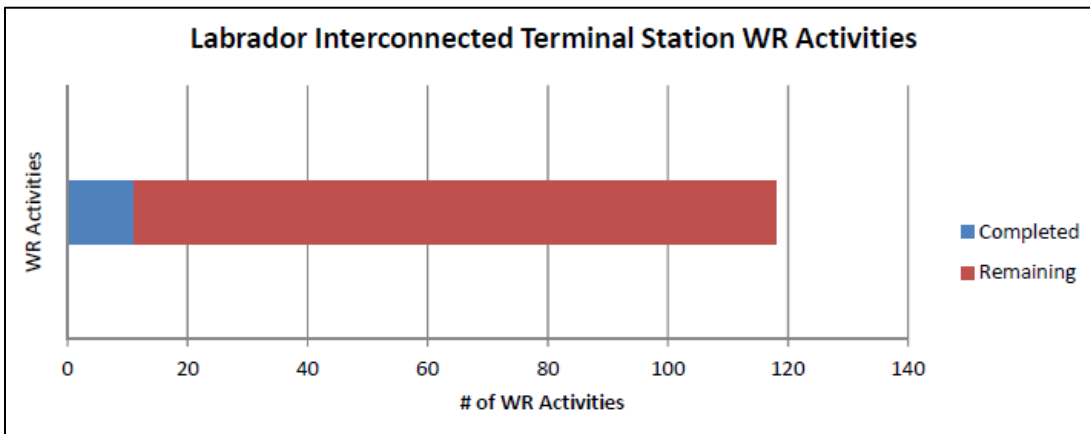

Figure 16: 2022 Terminal Station WR Activities for the Labrador Interconnected System (April 15, 2022)

- 1 The following is a summary of the terminal station work plan activities scheduled for 2022:
- 2
 - Complete 22 six-year breaker maintenance procedures;
- 3
 - Replace 11 breakers, one of which is an air blast circuit breaker;
- 4
 - Install one breaker that is not a replacement;
- 5
 - Operate all 69 kV and above breakers once;
- 6
 - Complete 18 trip from protection breaker maintenance procedures;
- 7
 - Complete 14 six-year power transformer maintenance procedures and 14 six-year power
- 8 transformer Doble maintenance procedures;

- 1 • Complete Oil Quality and Dissolved Gas Analysis Program for power transformers and tap
- 2 changers;
- 3 • For power transformers, complete: two oil refurbishments, one radiator replacement, 24
- 4 bushing replacements on four transformers, and install one online oil dehydrator and seven
- 5 online gas monitors;
- 6 • Replace four power transformers;
- 7 • Complete annual maintenance on all terminal station battery banks;
- 8 • Replace two battery banks and one battery charger;
- 9 • Complete PM activities on 100 disconnect switches;
- 10 • Replace 14 disconnect switches;
- 11 • Install one disconnect switch that is not a replacement;
- 12 • Replace 21 instrument transformers;
- 13 • Install capacitor bank;
- 14 • Replace protective relays for six transmission lines, three power transformers, and one bus
- 15 protection scheme;
- 16 • Install/upgrade six breaker failure protection schemes;
- 17 • Install one digital fault recorder;
- 18 • Replace one data alarm system;
- 19 • Install transformer paralleling on one power transformer;
- 20 • Complete 18 six-year protection and control maintenance procedures at 12 terminal stations;
- 21 • Complete 58 six-year instrument transformer maintenance procedures;
- 22 • Complete 58 six-year instrument transformer Doble maintenance procedures;
- 23 • Install fire protection in one terminal station;
- 24 • Replace lighting in one terminal station;
- 25 • Upgrade four terminal station equipment foundations;
- 26 • Install one control building; and

- 1
 - Complete infrared scans at all terminal stations.



Appendix A

Details of Terminal Station Preventive Maintenance Activities

1 Introduction

2 The following outlines Hydro's PM criteria for the various major asset classes within terminal stations.

3 Power Transformers and Shunt Reactors

- 4 • 120-day PM: cooling fan function testing, operational data collection, and visual inspection;
- 5 • Oil Sample PM (one year by default, more frequently as needed): dissolved gas analysis, oil
6 quality, and moisture;
- 7 • Furan PM (four years by default, one year as needed): to test the degree of polymerization
8 ("DP") of the paper;
- 9 • Six-year PM: electrical testing (Doble testing, winding resistance, winding insulation resistance,
10 protective device insulation resistance, surge arrester grounding continuity), protective device
11 function testing, tap changer function testing, cooling fan function testing, and visual inspection;
12 and
- 13 • Hydro's current replacement criteria for power transformer replacement (46 kV and above) is
14 based upon one of the following:
 - 15 ○ Condition based upon DP <400 for network transformers and <500 for generator step-up
16 transformers in Asset Criticality A;
 - 17 ○ Uncontrollable gassing which is an indication of an internal fault; or
 - 18 ○ Requirement for major refurbishment in the near term (to maintain/restore reliability) but
19 replacement is a lower-cost alternative.

20 Circuit Breakers

- 21 • 120-day PM: visual inspection, check pressures for air and/or SF₆, record heater amps;
- 22 • Annual: operate breaker PM is completed to confirm operation once per year;
- 23 • Oil sample from oil circuit breakers every three years;
- 24 • Every four years the following is completed for air blast circuit breakers: conductor; timing; trip
25 coil measurement; check auxiliary contact; check pressure switches; function test breaker; and
26 measure trip coil resistance;

- 1 • Every six years the following is completed for SF₆ circuit breakers: check SF₆ pressure; check
2 operating mechanism pressure; check conductor; measure trip coil resistance; check pressure
3 settings; check primary connections; lubricate mechanism; and measure timing and function
4 test breaker; and

- 5 • Every six years the following is completed for oil circuit breakers: change oil in compressor;
6 check dash pot oil level, breaker in open position; check pressure switches and record, if
7 applicable; inspect contactors; lubricate operating mechanism; measure and record run time of
8 compressor from cut-in to cut-out; measure interrupter resistors (138 kV KSO only), check
9 bushings and wipe down, if required; complete a dielectric test ASTM D877 of the oil; perform
10 megger of each phase to ground with breaker; and perform doctor and timing.

11 **Protective Relays**

- 12 • Six-year PM inspection: function test each protective relay one at a time—clean, dust, and
13 inspect connections; connect the relay test equipment to the relay; configure the relay test
14 equipment settings to those required for the relay; function test each in-service function of the
15 relay using the relay test equipment; troubleshoot the relay if it fails any function tests; record
16 and save the results in the relay testing software; and return relay to service;

- 17 • For electromechanical relays, perform the additional steps: remove glass and clean inside and
18 out; pull biscuit(s) and check for oxidation (tarnished); clean with a white eraser; unlock relay
19 and gently pull out of case; check for iron filings on operating disc, if equipped; clean contact
20 surfaces with a burnishing tool; and manually move disc to look for smooth operation and to
21 ensure it resets properly; and

- 22 • Every six years function test 230 kV circuit breakers from the protection during the scheduled
23 230 kV breaker PM.

24 **Current Transformers**

- 25 • On 120-day general inspection, the following is checked: bushings; tanks; oil leaks; rust/paint
26 condition; concrete base; primary connections; conduits; cabinets; and grounding; and

- 27 • Every six years the following is completed:
 - 28 ○ Wiring connections checked;

- 1 ○ Secondary connections checked;
- 2 ○ Heater amperage checked;
- 3 ○ Touch-up painting done, as required; and
- 4 ○ Doble test performed.

5 **Potential Transformers/Capacitive Voltage Transformers**

- 6 ● On 120-day general Inspection, the following is checked: bushings; tanks; oil leaks; rust/paint
7 condition; concrete base; primary connections; installed heater amperages; conduits; cabinets;
8 voltages at each secondary winding; and grounding; and
- 9 ● Every six years the following is completed:
 - 10 ○ Connections for position and tightness checked;
 - 11 ○ Grounding device checked;
 - 12 ○ Coupler box internally inspected;
 - 13 ○ Gaskets and gap clearances checked;
 - 14 ○ Heater amperage checked;
 - 15 ○ Touch-up painting, as required;
 - 16 ○ Perform Doble test;
 - 17 ○ Surge protection device in capacitor voltage transformer junction box checked/tested, if
18 fitted for wave-trap;
 - 19 ○ Ground switches cleaned and lubricated; and
 - 20 ○ Surge gap checked.

21 **Surge Arresters**

- 22 ● 120-day power transformer inspection, a visual inspection is performed; and
- 23 ● Every six years, a visual inspection and a Doble test are performed.

Disconnect Switches

- 120-day inspection is completed, which includes: visual check for alignment and signs of overheating; insulator conditions; and heater;
- Annual infrared scans to look for hot spots. The following guidelines shows temperature difference between phases and outlines response time required to address identified hot spots:

Priority	Temp. Difference (ΔT Phase to Phase)	Respond Within
1 (Emergency)	Visually Hot	24-hours
2	Above 50°C	One-week
3	20°C to 50°C	One-month
4	Below 20°C	One-year

- Every six years (one or three years as well if located in severe environmental contamination) the following is checked: all connections and contacts; switch operation; contacts are greased; and linkages and operating mechanism are lubricated. On motor operated disconnect switches the motor operation is checked and if load break, interrupter modules are checked.

Batteries and Chargers

- 120-day inspection includes: voltmeter checks; ammeter checks; alarm function testing; and visually checking battery condition as well as electrolyte levels for flooded cells. Distilled water may be added to flooded cells and completion of equalize charge procedure if required;
- Batteries and chargers are inspected and cleaned annually. During this inspection a conductance test is performed on all the cells and straps with a Midtronics battery tester. For flooded cells the specific gravity is also checked on all cells; and
- Discharge testing is completed for all battery banks during factory acceptance testing and is scheduled to be completed on Criticality A and B flooded cell banks after ten years of being in service and then every five years thereafter. Criticality A and B VRLA¹ banks are discharge tested every two years.

¹ Valve-regulated lead acid (“VRLA”).

1 **Air Systems**

- 2 • Compressor annual PM: change deteriorated disposable parts; cleaning; record operational
- 3 data; performance testing; protective device function testing, and visual inspection;
- 4 • Monthly air system PM: cleaning; record operational data; performance testing; protective
- 5 device function testing; and visual inspection; and
- 6 • Compressor overhauls: overhauls are based on the inspections performed, as well as
- 7 experience. Factors considered for compressor overhauls are: excessive oil consumption;
- 8 change in inter-stage pressure/back pressure; excessive time to bring system up to pressure; oil
- 9 leaks; broken valve spring/overheating; excessive noise; and vibration, etc.

10 **Grounding**

- 11 • 120-day PM: visual inspection; and
- 12 • Grounding is upgraded as a result of visual inspections and grounding analysis completed in
- 13 accordance with IEEE² 80-2013.

14 **Capacitor Banks**

- 15 • 120-day PM: record operational data, blown fuse replacement, and visual inspection; and
- 16 • Six-year PM: record operational data, electrical testing (capacitance, insulation resistance),
- 17 blown fuse replacement, cleaning, and visual inspection.

18 **Synchronous Condensers**

- 19 • Minor inspections, performed on year one and year two of a three-year cycle, include:
 - 20 ○ Check/monitor operating parameters (bearing temperatures, vibration, etc.) prior to unit
 - 21 coming offline and after inspection (prior to being released back to service);
 - 22 ○ Drain oil system and sumps. Inspect oil sump, replace filters and refill. Run oil through filter
 - 23 press when refilling. Repair and/or report any issues. Replace any required gaskets;
 - 24 ○ Remove and visually inspect outer end covers and inner baffles including mounting
 - 25 hardware. Repair or note any issues;

² Institute of Electrical and Electronic Engineers (“IEEE”).

- 1 ○ Take oil samples before and after oil filtering;
- 2 ○ Remove the bearing pedestal cap and top half of the bearing. Inspect and check clearance
- 3 and cap pinch;
- 4 ○ Inspect piping connections, oil fittings, oil flinger rings, bearing cap, upper half of the
- 5 bearings;
- 6 ○ Inspection of the fan blades and shrouds;
- 7 ○ Check high pressure lift system. Take shaft lift measurements at start and after inspection
- 8 before returning unit to service and check oil filters. Replace filters if required;
- 9 ○ Verify speed sensor clearance by rotating unit by hand before returning to service;
- 10 ○ Replace intake air filters;
- 11 ○ Complete electrical tests on stator, rotor, and bearing pedestals including insulation
- 12 resistance, polarization index and rotor field pole voltage drop;
- 13 ○ Visually inspect rotor V-blocks, pole windings and collars;
- 14 ○ Inspection of damper winding ring assembly for signs of movement, bolts loosening, or
- 15 copper cracking;
- 16 ○ Tap-test stator wedges;
- 17 ○ Inspect surge caps and lightning arrestors;
- 18 ○ Inspect slip rings. Disassemble brush rigging and inspect and cleaning. Install new brushes,
- 19 as required;
- 20 ○ Complete general cleaning and maintenance of components;
- 21 ○ Perform any required maintenance items identified for follow up on previous inspection;
- 22 and
- 23 ○ Reassemble unit, test-run and complete vibration and other operational checks.

- 24 ● Major inspections, performed on year three of a three-year cycle, include:
- 25 ○ Complete items performed as part of the scope of the minor inspection;
- 26 ○ Pull rotor and inspect the rotor and stator (further details below);

- 1 ○ Remove bottom halves of bearings and complete set of checks;
- 2 ○ Clean inside bearing pedestals;
- 3 ○ Replace thrust bearing and install new seals/gaskets; and
- 4 ○ Drain oil from reservoir and check screens, replace if required.

5 Stator and rotor inspections, performed as part of the scope of the major inspections, include the
6 following checks, as well as any additional items identified for follow up on previous inspections:

7 ● Stator:

- 8 ○ Complete a thorough inspection of stator including windings, frame, end covers, etc. Tap-
9 test stator wedges;
- 10 ○ Inspect frame hold down bolts, soleplates, grout and dowels for looseness or evidence of
11 movement;
- 12 ○ Check oil coolers for mechanical damage to tubes, corrosion and leakage;
- 13 ○ Check for any evidence of fretting on stator frame;
- 14 ○ Visually inspect stator core for damage and looseness to laminations, dirt, oil, foreign
15 obstacles, overheating and corona activity. Note findings and clean stator as required; and
- 16 ○ Clean stator core.

17 ● Rotor:

- 18 ○ Check rotor V-blocks, coil braces and coil tightness. Check for damage and erosion;
- 19 ○ Check rotor field poles for insulation fretting and migration;
- 20 ○ Check rotor field coils for damage and signs of overheating;
- 21 ○ Check damper bars and resistance rings for damage and tightness;
- 22 ○ Clean rotor; and
- 23 ○ Check for looseness, vibration, or movement of assembling hardware. Check for improper
24 locking or peening of locking devices.

Appendix B

2021 Terminal Station and Transmission Line Project Status

Table B-1: Terminal Station Projects

Project Description	Status of 2021 Planned Construction Completion
In-Service Failures – Various Sites	Complete (See Note 1)
Replace Transformer T7 – Holyrood (SY20) ¹	(See Note 2)
Wabush Terminal Station Upgrades	(See Note 3)
Upgrade Circuit Breakers (MY20) ² – Various Sites	Complete (See Note 4)
Upgrade Circuit Breakers (MY22) – Various	(See Note 5)
Additions for Load – Wabush Substation	(See Note 6)
Purchase SF6 Gas Recovery Systems	Complete
Replace Transformer T2 – Holyrood Generating Station	(See Note 7)
Wabush L34/L35 Line Protection Upgrades	(See Note 11)
Upgrades for Future Retirement of Stephenville Gas Turbine	(See Note 15)
Terminal Station Refurbishment and Modernization Various Sites (Multi-Year 2020)	
<ul style="list-style-type: none"> ● Replace Protective Relays 	(See Note 8)
<ul style="list-style-type: none"> ● Upgrade 230kV Terminal Station – Wabush 	Complete
<ul style="list-style-type: none"> ● Upgrade Data Alarm Systems – Holyrood 	Complete
<ul style="list-style-type: none"> ● Upgrade Reclosing Circuit Breakers – Holyrood 	Complete
Terminal Station Refurbishment and Modernization Various Sites (Multi-Year 2021)	
<ul style="list-style-type: none"> ● Refurbish and Upgrade Power Transformers 	Complete
<ul style="list-style-type: none"> ● Install Fire Protection in 230kV Stations – Stony Brook 	Complete
<ul style="list-style-type: none"> ● Replace Instrument Transformers 	Complete (See Note 9)
<ul style="list-style-type: none"> ● Upgrade Breaker Failure Protection 	Complete
<ul style="list-style-type: none"> ● Upgrade Fault Recorders – Happy Valley 	(See Note 10)
<ul style="list-style-type: none"> ● Upgrade 230kV Terminal Station Part 2 – Wabush 	(See Note 11)
<ul style="list-style-type: none"> ● Upgrade Data Alarm Systems – Massie Drive 	Complete
<ul style="list-style-type: none"> ● Replace Disconnects 	Complete (See Note 12)
<ul style="list-style-type: none"> ● Insulator Replacement – Various Sites 	Complete (See Note 13)
<ul style="list-style-type: none"> ● Upgrade Station Lighting – Holyrood 	Complete

¹ SY20 represents a 2020 single-year project.

² MY20 represents a multi-year project ending in 2020.

Project Description	Status of 2021 Planned Construction Completion
Terminal Station Refurbishment and Modernization Various Sites (Multi-Year 2022)	
● Refurbish and Upgrade Power Transformers	(See Note 14)
● Install Fire Protection in 230kV Stations – Massie Drive	(See Note 15)
● Replace Instrument Transformers	(See Note 15)
● Upgrade Breaker Failure Protection	(See Note 15)
● Perform Grounding Upgrades	(See Note 15)
● Upgrade Data Alarm Systems – Oxen Pond	(See Note 15)
● Replace Disconnects	(See Note 15)
● Replace Protective Relays	(See Note 15)
● Upgrade Terminal Station Foundation (SY21)	Complete
● Upgrade Transformer Parallelling – Hardwoods	(See Note 15)
● Upgrade Station Lighting – Stony Brook	(See Note 15)
● Replace Surge Arresters (SY21)	Complete
● Replace Terminal Station Battery Banks and Chargers	Complete (See Note 16)
● Upgrade Fault Recorders – Howley	Complete (See Note 16)
● Upgrade Cables (SY21)	Complete (See Note 17)

Table B-2: Transmission Line Projects

Project Description	Status of 2021 Planned Construction Completion
Perform WPLM	(See Note 18)
Muskrat Falls to Happy Valley Interconnection	(See Note 19)

1 Notes

- 2 1) In 2021, the Terminals In-Service Failures project executed: one synchronous condenser rotor
3 pole replacement, one mobile substation refurbishment, 18 power transformer protective
4 device replacements, one 230 kV circuit breaker major overhaul, 24 low voltage transformer flex
5 lead replacements, one 125 VDC battery bank replacement, one capacitive voltage transformer
6 replacement, one neutral surge arrester replacement, and one potential transformer
7 replacement.

- 1 **2)** As a result of Hydro’s decision to maintain Transmission Line L1301 to supply power or act as a
2 back up power supply to Labrador East for the winter of 2021–2022, Churchill Falls Transformer
3 T31 was not available in 2021 to replace Holyrood Transformer T7. Hydro performed an analysis
4 of the resulting risk and confirmed that there will be low risk to customers as a result of the
5 deferral. Hydro advised Newfoundland Power of this decision. Removal of the old Holyrood
6 Transformer T7 and its foundation, and installation of a new concrete pad and oil containment
7 system, was completed in 2020 and the replacement of Holyrood Transformer T7, with
8 relocated Churchill Falls Transformer T31, is now planned for 2022.
- 9 **3)** The civil construction planned for 2021 was delayed until 2022 to allow for completion of
10 surveying and geotechnical work that was delayed due to winter site conditions.
- 11 **4)** Three 230 kV circuit breaker replacements were completed in 2021. However, due to plans in
12 another project to replace the generator breakers at Bay d’Espoir with higher capacity breakers
13 in 2022 through 2024, three 230 kV breaker replacements, that were part of the original basis
14 for this project, were transferred to another project for completion in future years in order to
15 utilize those ‘replaced’ breakers in other non-generator locations.
- 16 **5)** Three 138 kV and two 69 kV circuit breaker replacements were completed in 2021, as well as
17 one 69 kV breaker refurbishment. One planned 69 kV breaker refurbishment was carried over
18 into 2022 due to vendor supply chain issues resulting from COVID-19 impacts. The project is
19 being extended to 2023 to allow one 69 kV breaker replacement at Holyrood to be deferred one
20 year, from 2022 to 2023, and one 138 kV breaker replacement to be changed to a refurbishment
21 and deferred one year from 2022 to 2023.
- 22 **6)** The civil construction planned for 2021 was delayed until 2022 to allow for completion of
23 surveying and geotechnical work that was delayed due to winter site conditions. The voltage
24 regulators planned for 2021 were removed from scope as a result of a load reforecast that
25 requires a future transformer installation, negating the requirement for the voltage regulators.
- 26 **7)** Project was substantially completed in 2021 but weather delays pushed the completion into
27 early 2022.
- 28 **8)** The following scope items have carried over to future years within this project: protective relay
29 replacements for transmission line protection at two sites, and bus protection at one site.

- 1 **9)** The following scope items were transferred for completion in 2022: seven instrument
2 transformers at three sites due to quality issues and/or revenue metering approval delays.
- 3 **10)** This scope was delayed to 2022 to allow completion of another project that utilized a common
4 panel.
- 5 **11)** Differential line protection scope was delayed to 2022 to align with customers' plans to
6 complete their related construction in 2022.
- 7 **12)** One disconnect switch replacement scope was transferred for completion in 2022 to allow more
8 urgent work to be completed associated with another project.
- 9 **13)** Several insulator replacements were cancelled, as they were associated with assets that are no
10 longer required.
- 11 **14)** A transformer oil dehydrator installation was delayed into 2022, due to a delay in equipment
12 delivery. Three online gas monitor systems' commissioning were delayed into 2022 due to cold-
13 weather impacts on the associated fibre optic work.
- 14 **15)** No planned 2021 construction.
- 15 **16)** Construction was advanced from 2022 and was completed in 2021 due to resource availability.
- 16 **17)** Scope associated with a cable trench reinforcement was transferred to another project for
17 completion in 2022.
- 18 **18)** The 2021 scope of work for the WPLM included: the inspection and treatment of 2,278 poles
19 and the replacement of: 21 poles, 14 sets of kneebracing, 22 crossarms, and 7 sets of cross
20 bracing. Work that carried over into 2022 included: one pole and two crossarms – TL209; one
21 set of kneebracing – TL234; two insulators, five dampers, one guy – TL250; one damper – TL254;
22 and four insulators – TL226.
- 23 **19)** The transmission line build was completed and placed in service in 2021. However, work
24 remains to be completed under the Muskrat Falls to Happy Valley Interconnection project to
25 add additional transformation capacity at the Happy Valley Terminal Station, planned for
26 completion in summer 2022.

Attachment 1

Terminal Station Asset Management Overview

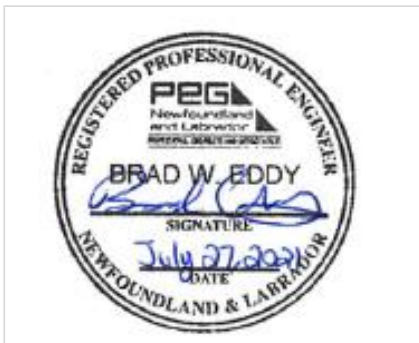

2022 Capital Budget Application

Terminal Station Asset Management Overview Version 6

July 2021

A report to the Board of Commissioners of Public Utilities



1 **Executive Summary**

2 Newfoundland and Labrador Hydro (“Hydro”) has developed an ongoing capital program to replace or
3 refurbish assets as they reach the end of their design life or require attention due to obsolescence or
4 anticipated failure.

5 Before 2017, Hydro’s terminal station projects could be divided into two categories: (1) stand alone and
6 (2) programs. Programs included projects that are proposed year after year to address the upgrade or
7 replacements of deteriorated equipment, such as disconnects or instrument transformers, and have
8 similar justification each year. Stand alone would include projects that do not meet the definition of a
9 program. Hydro has typically had as many as 15 separate program-type terminal station projects in its
10 capital budget applications, with each program based upon a particular type of asset.

11 Starting with the 2017 Capital Budget Application (“CBA”),¹ Hydro implemented a change to how the
12 terminal station projects are submitted for consideration by the Board of Commissioners of Public
13 Utilities (“Board”). Hydro has consolidated the programs into the Terminal Station Refurbishment and
14 Modernization project (“Project”), thereby improving regulatory efficiency and easing the administrative
15 effort for both the Board and Hydro and allowing Hydro to look for opportunities to realize efficiencies
16 by improving coordination of capital and maintenance work in terminal stations.

17 In 2019, Hydro submitted a revised Terminal Station Asset Management Overview (“Asset Management
18 Overview”) to provide an updated overview of Hydro’s asset maintenance philosophies in one
19 document. Hydro will submit the Project within annual CBAs going forward, proposing required terminal
20 station work and referencing this Asset Management Overview document.

¹ “2017 Capital Budget Application,” Newfoundland and Labrador Hydro, July 28, 2016.

Contents

Executive Summary.....	i
1.0 Introduction	1
1.1 Changes in Version 6.....	2
2.0 Background	2
2.1 Newfoundland and Labrador Hydro’s Terminal Stations	2
2.2 Terminal Station Infrastructure	2
3.0 Terminal Station Capital Projects.....	3
3.1 Historical Terminal Station Capital Projects.....	3
3.2 Hydro’s Approach to Terminal Station Capital Project Proposals	3
3.3 Benefits of This Approach	5
4.0 Asset Management Programs.....	6
4.1 Electrical Equipment	6
4.1.1 High-Voltage Instrument Transformer Replacements.....	6
4.1.2 High-Voltage Switch Replacements	9
4.1.3 Surge Arrester Replacement	11
4.1.4 Insulator Replacement.....	13
4.1.5 Grounding Refurbishment and Upgrades	14
4.1.6 Power Transformer Upgrades and Refurbishment.....	15
4.1.7 Circuit Breaker Refurbishment and Replacements.....	20
4.1.8 Station Service Refurbishment and Upgrades	21
4.1.9 Battery Banks and Chargers	23
4.1.10 Install Breaker Bypass Switches	23
4.1.11 Replace Station Lighting.....	25
4.1.12 Synchronous Condensers.....	26
4.2 Civil Works and Buildings	26
4.2.1 Equipment Foundations.....	26
4.2.2 Fire Protection.....	28
4.2.3 Control Buildings.....	29
4.3 Protection, Control, and Monitoring	30
4.3.1 Protection and Control Upgrades and Refurbishment	30

1 1.0 Introduction

2 Hydro has 69 terminal stations that contain electrical equipment, such as transformers, circuit breakers,
3 instrument transformers, disconnect switches, and associated protection and control relays and
4 equipment required to protect, control, and operate Hydro's electrical grid.

5 Hydro's Asset Management System governs the life cycle of its terminal station assets. This system
6 monitors, maintains, refurbishes, replaces, and disposes of assets with the objective of providing safe,
7 reliable electrical power in an environmentally responsible manner at least cost. Within this system,
8 assets are grouped, such as breaker, transformers, grounding systems, buildings, and sites. This allows
9 the asset managers to establish consistent practices for equipment specification, placement,
10 maintenance, refurbishment, replacement, and disposal. These practices mean that the monitoring,
11 assessments, action justifications for capital refurbishment, and replacement for asset-sustaining
12 projects are consistent. Hydro established programs which enact these practices for groups or sub-
13 groupings of assets, for example high-voltage switch replacements.

14 Part of Hydro's annual capital program is a sustained effort to ensure the safety and reliability of
15 terminal station assets. Historically, the Board's approval for this effort has been requested by Hydro
16 submitting either individual projects for particular assets, or programs for station-sustaining work in its
17 CBA. This approach can result in a segmented view of the expenditures to sustain station assets. For
18 example, in the 2016 CBA, there were 15 separate program-type projects submitted. The expenditures
19 detailed in these projects according to the Board's classifications are normal capital expenditures. This
20 situation provides an opportunity to increase regulatory efficiency.

21 With the 2017 CBA, Hydro consolidated planned terminal station-sustaining work into the Project.
22 Additionally, Hydro submitted the Terminal Station In-Service Failures to cover the replacement or
23 refurbishment of failed equipment, or incipient failures. Hydro is utilizing the Asset Management
24 Overview as a reference for both projects to streamline and focus information submitted. The Asset
25 Management Overview provides supporting information which was historically, annually presented for
26 similar classification projects in the CBA. The remainder of this document provides information as to the
27 assets involved, an overview of each asset program, and how this document will be updated in the event
28 of changes to Hydro's asset management philosophies.

1 Hydro will provide an updated Asset Management Overview as it implements changes to its asset
2 management philosophies appropriate for inclusion in the Asset Management Overview.

3 **1.1 Changes in Version 6**

4 Hydro submitted Version 6 of this document in the 2022 CBA. All material updates in this version are
5 shaded in grey and are summarized below:

- 6 • Addition to Section 4.1.1: added system concern as a criterion for instrument transformer
7 replacements; and
- 8 • Removed frequency monitoring additions from Section 4.3.1.

9 Minor changes to syntax have been made to improve readability. These minor changes have not been
10 shaded.

11 **2.0 Background**

12 **2.1 Newfoundland and Labrador Hydro's Terminal Stations**

13 Terminal stations play a critical role in the transmission and distribution of electricity. Terminal stations
14 contain electrical equipment, such as transformers, circuit breakers, instrument transformers,
15 disconnect switches, and associated protection and control relays and equipment required to protect,
16 control, and operate the Hydro's electrical grid. Stations act as transition points within the transmission
17 system, and interface points with the lower voltage distribution and generation systems. Hydro has 69
18 terminal stations throughout Newfoundland and Labrador.

19 **2.2 Terminal Station Infrastructure**

20 Stations contain the following infrastructure, which is described throughout this report:

- 21 • Transformers;
- 22 • Circuit breakers;
- 23 • Instrument transformers;
- 24 • Disconnect, bypass, and ground switches;
- 25 • Surge arresters;
- 26 • Grounding;

- 1 • Buswork;
- 2 • Steel structures and foundations;
- 3 • Insulators;
- 4 • Control buildings;
- 5 • Protection and control relays;
- 6 • Yards, fences, and access roads;
- 7 • Battery banks;
- 8 • Terminal station lighting; and
- 9 • Synchronous condensers

10 Many of Hydro's terminal stations were constructed in the 1960s. Annual capital commitment is needed
11 to sustain terminal station assets to ensure that Hydro can continue to provide customers with reliable
12 electrical service.

13 **3.0 Terminal Station Capital Projects**

14 **3.1 Historical Terminal Station Capital Projects**

15 In the 2016 CBA there were 22 individual terminal station projects which accounted for \$30 million, or
16 16% of the capital budget. Historically, Hydro's terminal station projects were divided into two
17 categories: (1) stand alone and (2) programs. Programs include projects that are proposed year after
18 year to address the required refurbishment or replacement of assets, such as disconnects or instrument
19 transformers, and have similar justification and other information presented each year. Of the 22
20 individual terminal station projects proposed in 2016, 15 were program-type projects. In the 2017 CBA,
21 Hydro consolidated the historical station projects into the Project.

22 **3.2 Hydro's Approach to Terminal Station Capital Project Proposals**

23 The programs now included in the Project are:

- 24 • Upgrade circuit breakers;
- 25 • Replace disconnect switches;
- 26 • Install fire protection;

- 1 • Replace surge arresters;
- 2 • Upgrade terminal station foundations;
- 3 • Refurbish control buildings;
- 4 • Replace station lighting;
- 5 • Replace battery banks and chargers;
- 6 • Upgrade terminal station for mobile substation;
- 7 • Install breaker bypass switches; and
- 8 • Protection and control refurbishment and upgrades.²

9 The Project excludes:

- 10 • Transformer replacement and transformer spares: Although transformer replacement fits within
11 the description of a terminal station program, these projects often have unique justification and
12 a high project cost and, therefore, are proposed separately.
- 13 • Activities which cannot be scheduled for inclusion in a CBA, as these will be submitted as either
14 supplemental to the CBA or executed in the Terminal Stations In-Service Failures project.
- 15 • Activities in response to additional load or reliability requirements, as these projects generally
16 have unique justification and will be proposed separately.
- 17 • Activities in response to significant isolated issues in a particular station such as replacement of
18 a failed power transformer, as these projects generally have unique justification, the projects
19 will be proposed separately.

20 Hydro continues to maintain individual records with regards to asset capital, maintenance, and
21 retirement expenditures and performance, which will be queried to support the development of the
22 annual capital plan.

² As noted in the “2017 Capital Budget Application,” Newfoundland and Labrador Hydro, July 28, 2016, vol. II, tab 13, the 2016 Upgrade Terminal Station Protection and Control Upgrade, Upgrade Protective Relays, Upgrade Fault Recorders, Upgrade Data Alarm Systems, and Install Breaker Failure Protection projects were combined in the Asset Management Overview and the Project as the Protection and Control Refurbishment and Upgrades Program.

1 This document is submitted to the Board as part of the 2022 CBA. Hydro will annually submit proposals
2 for the Terminal Station Refurbishment and Modernization project and Terminal Station In-Service
3 Failures project referencing the most recent Asset Management Overviews. Future CBAs will not include
4 a copy of the Asset Management Overview unless Hydro revises its contents. When the Asset
5 Management Overview is revised, Hydro will clearly denote such changes, highlighted in grey, for review
6 and approval by the Board.

7 **3.3 Benefits of This Approach**

8 As supporting information for programs changes infrequently, referencing the Asset Management
9 Overview in the Project documentation will eliminate the preparation and review of repetitious
10 information. Hydro estimates that this approach could save up to \$120,000³ annually, not including time
11 and costs for review by the Board and parties.

12 Hydro has a proactive Asset Management System which strives to anticipate future failures so that
13 refurbishment or replacement can be incorporated into a CBA. However, there are situations where
14 immediate refurbishment or replacement, which has not be included in an CBA, has to be undertaken
15 due to the occurrence of an unanticipated failure or the recognition of an incipient failure so as to
16 maintain the delivery of safe, reliable electricity at least cost. These situations seldom include
17 extenuating or abnormal circumstances and costs. With aging terminal station assets unanticipated
18 failures may increase. This increase will require additional future efforts to provide and review
19 regulatory documentation. By introducing a Terminal Station In-Service Failures project, there will be a
20 reduced need for that documentation and change management processes. Each year, Hydro will provide
21 a concise summary of the previous year's work.

22 Hydro expects the Project will provide opportunities whereby Hydro can further optimize capital and
23 maintenance work so as to minimize outages to customers and equipment as personnel look to further
24 coordinate work by location.

³ If the work undertaken in Hydro's 2017 Capital Budget Application's Terminal Station Refurbishment and Modernization project had been submitted as 12 individual projects, it is estimated preparation would be approximately \$10,000 per project.

1 **4.0 Asset Management Programs**

2 **4.1 Electrical Equipment**

3 **4.1.1 High-Voltage Instrument Transformer Replacements**

4 The protection, control, and metering devices such as protective relaying, power quality monitors, and
5 kWh meters used in generation and transmission systems are not manufactured to handle the currents
6 and voltages inherent to those systems. Measurement of the electricity's currents and voltages are
7 provided to these devices through a current transformer and a potential transformer, respectively.
8 Current transformers and potential transformers are collectively known as instrument transformers.
9 Hydro has approximately 900 individual high-voltage instrument transformers within the Island and
10 Labrador Interconnected Systems.

11 A high-voltage instrument transformer consists of an insulated electrical primary and secondary
12 winding, tank, and bushing components. The insulation system involves the use of insulating oil or dry
13 type insulation and a high-voltage porcelain bushing which allows the safe connection of the winding to
14 high-voltage conductors. The winding is enclosed in a steel tank.



Figure 1: 69 kV Current Transformer (Left) and Potential Transformer (Right)

1 Hydro manages planned budgeted Instrument Transformer replacements in **five** categories:

- 2 **1)** Condition
- 3 **2)** Polychlorinated Biphenyl Compliance Replacements
- 4 **3)** Manufacturer and model
- 5 **4)** Age; and
- 6 **5)** System Concern.

7 **Condition**

8 Deterioration or damage to the various instrument transformer components can result in the failure of
9 the unit to provide accurate measurements to metering, protection, and control devices, which may
10 affect the safe and reliable operation of the generation and transmission systems. Failure could also
11 result in an oil spill. Also, in some situations pieces of the instrument transformer may be forcibly
12 projected resulting in a safety risk for personnel in the area or damage to other infrastructure.

13 Damage to an instrument transformer normally results from vandalism, impacts from catastrophically
14 failed equipment, or accidental contact of mobile equipment. Upon such incidents, Hydro assesses the
15 electrical and physical integrity of an instrument transformer to determine if replacement is required.

16 Hydro monitors instrument transformers for physical and electrical deterioration by conducting regular
17 visual inspections of the units as part of its station inspection program plus regularly scheduled station
18 infrared inspections and electrical insulation testing.

19 Physical deterioration involves conditions such as oil leaks, rusting, or small chips and cracks in the
20 insulation. Figure 2 shows an example of rusting on a potential transformer tank.



Figure 2: Rusting Potential Transformer

1 Electrical deterioration is identified by conducting power factor testing at intervals which is used to
2 establish the rate and level of insulation degradation. Hydro uses Doble Engineering Company to provide
3 assistance with assessment of the test results, as required.

4 On an ongoing basis, Hydro's asset management personnel review the unit deterioration information
5 and determine when corrective maintenance or unit replacement is required. Hydro conducts minor
6 instrument transformer corrective maintenance such as painting and small bushing chip treatment.
7 External services to economically undertake major corrective maintenance or unit refurbishments do
8 not exist, so units requiring major corrective maintenance or refurbishments are replaced.

9 **PCB Compliance Replacements**

10 Environment Canada's PCB Regulations requires that by 2025 all instrument transformers will not have a
11 PCB concentration greater than 50 mg/kg. Instrument transformers are sealed oil filled units, where the
12 oil, which acts as an electrical insulator, has been known to contain PCBs for equipment prior to 1985.
13 Due to the age of the units and the risk of introducing contamination such as air into the unit, which
14 could impact the electrical integrity of instrument transformers, Hydro does not sample instrument
15 transformers. Therefore, establishing the actual PCB concentration in an instrument transformer is not
16 possible. Hydro, in consultation with manufacturers, has established that units manufactured before
17 1985 are suspected to contain PCBs in concentration levels greater than or equal to 50 mg/kg. Thus
18 Hydro has a program to replace all suspect oil-filled instrument transformers before 2025.

1 **Manufacturer and Model**

2 In 2010, Hydro experienced a failure of a 230 kV Asea IMBA current transformer. The failure analysis
3 recommended this manufacturer and model be replaced over time. These replacements are included in
4 this program. The last of these replacements is planned for 2024.

5 **Age**

6 Hydro targets replacement at 40 years of age to reduce the risk of in-service failures and minimize
7 service interruptions. Original equipment manufacturers (“OEM”) recommend that the life of an
8 instrument transformer is approximately 30–40 years. Recent in-service failures occurred between 20–
9 39 years of life (3 of which occurred between 29–39 years of life).

10 **System Concern**

11 System concern refers to a transient response of a specific make and model of instrument transformer
12 to a specific system transient condition that can contribute to over-stressing (and possibly damage)
13 equipment connected nearby. For example, following four 230 kV circuit breaker failures at Bay d’Espoir
14 Terminal Station 1 during the period of 2018–2019, a transient study identified three instrument
15 transformers with a system concern that likely contributed to over-stressing these circuit breakers and
16 thereby contributed to their failure.

17 **Exclusions from Instrument Transformer Replacement Program**

18 Modern-day circuit breaker technology includes current transformers embedded in the circuit breaker
19 bushings. Therefore, where possible, external current transformers will be displaced by bushing current
20 transformers as circuit breakers are replaced, and such current transformers are not included in this
21 program.

22 **4.1.2 High-Voltage Switch Replacements**

23 High-voltage switches are used to isolate equipment either for maintenance activities or for system
24 operation and control (“disconnect switches”). Switches are also used to bypass equipment to prevent
25 customer outages while work is being performed on the equipment. Disconnect switches are an
26 important part of the Work Protection Code as they provide a visible air gap (i.e., visible isolation) for
27 utility workers. Work protection is defined as “a guarantee that an ISOLATED, or ISOLATED and DE-
28 ENERGIZED, condition has been established for worker protection and will continue to exist, except for

1 authorized tests.” Proper operation of disconnect switches is essential for a safe work environment and
2 for reliable operation.

3 The basic components of a disconnect switch are the blade assembly, insulators, switch base and
4 operating mechanism. The blade assembly is the current carrying component in the switch and the
5 operating mechanism moves it to open and close the switch. The insulators are made of porcelain and
6 insulate the switch base and operating mechanism from the current carrying parts. The switch base
7 supports the insulators and is mounted to a metal frame support structure. The operating mechanism is
8 operated either manually, by using a handle at ground level to open and close the blade, or by a motor-
9 operated device, in which case the switch is known as a motor-operated disconnect. A disconnect and
10 its associated components are shown in Figure 3.

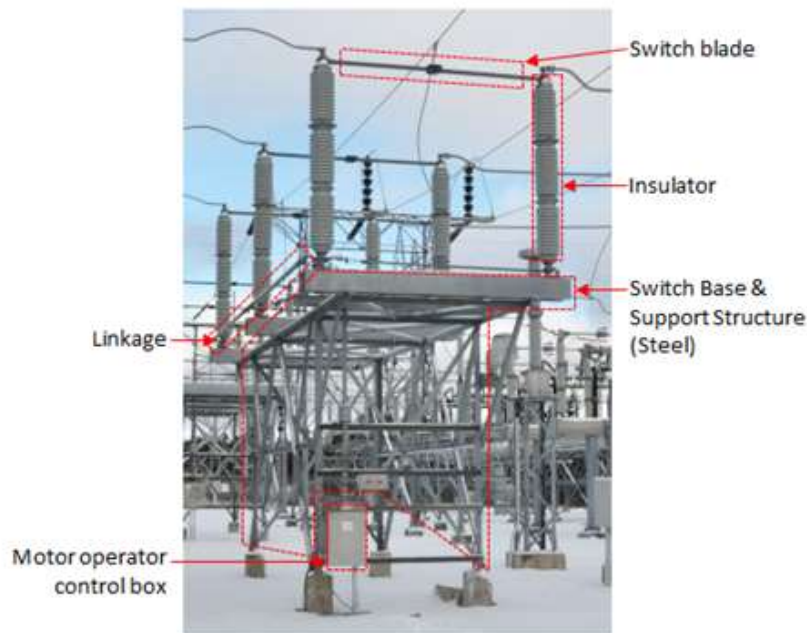

Figure 3: Various Components of a High-Voltage Disconnect Switch

11 Hydro monitors the condition of its switches by conducting regular visual inspections of the units as part
12 of its station inspection program and its infrared inspection program and by reviewing reports from the
13 JDE E1 work order system or staff who operate the switch, outlining problems such as inoperable

1 mechanical linkages, misalignment of switch blades, broken insulators, and seizing of moving parts.
2 Asset management personnel determine the timing of corrective maintenance or switch replacement. If
3 the required parts are available then repairs are undertaken as part of ongoing maintenance. Switches
4 that have operating deficiencies and have reached a service life of 50 years or greater are designated for
5 replacement. Switches that have no replacement parts available due to obsolescence, damaged beyond
6 repair, or cannot be economically repaired and do not require immediate replacement are designated
7 for replacement under this program.

8 Figure 4 shows an example of a badly damaged disconnect switch.



Figure 4: Broken Insulator on 69 kV Disconnect Switch

9 **4.1.3 Surge Arrester Replacement**

10 Surge arresters (also known as lightning arresters) are used on critical terminal station equipment to
11 protect that equipment from voltage due to lightning, extreme system operating voltages, and switching
12 transients, collectively called “overvoltages.” In these situations, voltage at the equipment can rise to
13 levels which could damage the equipment’s insulation. The surge arresters act to maintain the voltages
14 within acceptable levels. Without surge arresters, equipment insulation could be damaged and faults
15 could result during overvoltages. Hydro typically has surge arresters installed on the high- and low-
16 voltage sides of power transformers rated 46 kV and above.

1 Figure 5 shows the arresters on a 230 kV power transformer.



Figure 5: Western Avalon Terminal Station Transformer T3 230 kV Surge Arresters

2 Surge arresters can fail because of the cumulative effects of prolonged or multiple overvoltages. When a
3 surge arrester fails, it is not repairable and must be replaced immediately otherwise the major
4 equipment may be exposed to damaging overvoltages. The older arrester designs have a higher
5 incidence of failure than the newer designs.

6 Hydro's surge arrester asset management program replaces surge arresters based upon the following
7 criteria:

- 8 ● Removal of gapped type arresters with zinc oxide design due to enhanced performance;
- 9 ● Replacement of units due to a condition identified through visual inspections for chips or cracks
10 or electrical testing such as power factor testing;
- 11 ● If failures occur on a given transformer, all arresters on both the high and low side are
12 considered for replacement either immediately or in a planned fashion; and

- 1 • If transformers are being planned for maintenance or other capital work, consideration is given
2 to changing aged arresters on a common outage. Hydro targets replacement at 40 years of age,
3 to reduce the risk of in-service failures and minimize service interruptions.

4 **4.1.4 Insulator Replacement**

5 Insulators provide electrical insulation between energized equipment and ground. When an insulator
6 fails and a fault occurs, safety hazards and/or customer outages may occur.

7 Insulators consist of insulating material such as glass, porcelain, and metal end fittings to attach the
8 insulator to the structure and the conductor. The metallic hardware is mated with the porcelain or glass
9 insulator using cement. There are different styles of insulators. An example of a station post insulator is
10 shown in Figure 6.

11 Terminal stations contain post type, cap and pin-top, multi-cone, and suspension type insulators.



Figure 6: Multi-Cone Type Insulator Prone to Failure due to Cement Growth

1 For insulators using porcelain, cement is used in mating the porcelain and metal hardware. Some older
2 insulators have been damaged by a phenomenon known as cement growth. This is a common problem
3 in the utility industry. In such situations, water is absorbed into the concrete, during freeze/thaw cycles,
4 causing swelling of the cement placing stress upon the porcelain. Over time, the increasing pressure
5 caused by cement growth will crack or break the porcelain resulting in insulator failure. In such
6 situations, porcelain may fall presenting a safety hazard to crews or damaging equipment below. Also
7 faults resulting in outages to customers often occur, when insulator failure leads to flash over. Some
8 time ago, insulator manufacturers identified and researched cement growth problems and have
9 improved their cement quality to eliminate this problem.

10 Hydro carries out detailed insulator surveys by geographical area. Hydro identifies any insulator types
11 known to be prone to failure due to cement growth and replaces these insulators under this program.

12 **4.1.5 Grounding Refurbishment and Upgrades**

13 The grounding system in a terminal station or distribution substation consists of copper wire used in the
14 ground grid under the station, gradient control mats for high-voltage switches, and bonding wiring
15 connecting the structure and equipment metal components to the ground grid. In the event of a ground
16 fault, electrical potential differences will exist in the grounding system. If the grounding system is
17 inadequate or deteriorated these differences may be hazardous to personnel. These potential
18 differences are known as step and touch potentials. Effective station grounding reduces these potentials
19 to eliminate the hazard.



Figure 7: Typical Grounding Connection on Terminal Station Fence

1 To determine whether grounding upgrades are required, Hydro performs a step and touch potential
2 analysis of the terminal station or distribution substation. Step and touch potential analysis involves the
3 gathering of field data and conducting analysis in order to determine if ground grid modifications are
4 required to eliminate step and touch potential hazard. This engineering is conducted in accordance with
5 IEEE⁴ Standard 80-2000. Grounding systems with hazardous step and/or touch potentials are upgraded,
6 by adding additional equipment bonding, gradient control mats, or copper wire to the station grounding
7 grid. In the case where the terminal station grounding infrastructure has deteriorated with age, or is
8 damaged due to accidental contact or vandalism, the grounding system is refurbished by repairing
9 damage or replacing missing infrastructure. Upgrades and refurbishments are made in accordance with
10 Hydro's Terminal Station Grounding Standard.

11 **4.1.6 Power Transformer Upgrades and Refurbishment**

12 Power transformers are a critical component of the power system. Transformers allow the cost-effective
13 production, transmission, and distribution of electricity by converting the electricity to an appropriate
14 voltage for each segment of the electrical system and allow for economic construction and operation of
15 the electrical system.

16 Hydro has 118 power transformers and three oil-filled shunt reactors 46 kV and above, as well as several
17 station service transformers at voltages lower than 46 kV.

18 The basic components of a power transformer are:

- 19 • Transformer steel tank containing the metal core and paper insulated windings, oil which is part
20 of the insulating system, and a gasket system which keeps the oil from getting into the
21 environment;
- 22 • Bushings mounted to the top of the transformer tank, which connects the windings to the
23 external electrical conductors;
- 24 • Radiators and cooling fans, which remove heat for the transformer's internal components;
- 25 • On-Load tap changer, which is a device attached internally or externally through which
26 transformer voltages are maintained at acceptable levels; and

⁴ Institute of Electrical and Electronics Engineers ("IEEE").

- 1 • Protective devices to ensure the safe operation of the transformer such as gas detector relays,
- 2 oil level and temperature relays, and gauges.

- 3 Figure 8 shows a picture of a 75 MVA, 230/66 kV power transformer at the Hardwoods Terminal Station.



Figure 8: Power Transformer

- 4 Transformers are expensive components of the electrical system. Hydro, like many North American
- 5 utilities, is working to maximize and extend the life of its transformers by regularly assessing their
- 6 condition; executing regularly scheduled maintenance and testing and undertaking refurbishment or
- 7 corrective actions as required. Transformers regularly undergo visual inspection as part of Hydro's
- 8 terminal station inspection and scheduled preventive maintenance and testing, to identify concerns
- 9 regarding the following transformer conditions:

- 10 • Insulating oil and paper deterioration;

- 1 • Oil moisture content;
- 2 • Oil leaks;
- 3 • Tank, radiators, and other component rusting/corrosion;
- 4 • Tap changer component wear or damage;
- 5 • Damaged/deteriorated and PCB-contaminated bushings;
- 6 • Failure of the protective devices; and
- 7 • Cooling fan failures.

8 Details on the assessment procedures and corrective action for each of these concerns are provided
9 below.

10 **Transformer Oil Deterioration**

11 The insulating oil in a transformer and its tap changer diverter switch is a critical component of the
12 insulation system. Normal operation of a transformer will cause its oil to deteriorate. Deterioration
13 results from a number of causes such as heating, internal arcing of electrical components, or ingress of
14 water moisture into the transformer. Deterioration of the oil will affect its function in the insulation
15 system and may damage the paper component of the insulation system. Unacceptable levels of
16 deterioration can affect the reliable operation of the transformer. To ensure that the oil in a transformer
17 is of an acceptable quality, Hydro has an oil monitoring program, in which an oil sample is obtained
18 periodically⁵ from each transformer and analyzed by a professional laboratory. The test results are
19 assessed to determine the level of deterioration. If an unacceptable level of deterioration is identified,
20 required corrective action is identified by asset management personnel. This action entails either the
21 refurbishment of the oil to improve its quality or the replacement of the oil.

22 **Moisture Content**

23 Oil samples are also analyzed to determine their moisture content. Moisture in a power transformer
24 may be residual moisture or may result from the ingress of atmospheric moisture. Oil and insulating
25 paper with high moisture content has a reduced dielectric strength; therefore, its performance as an
26 electrical insulator is diminished. To address transformers with high moisture content, Hydro will either

⁵ The sampling period is annual for most transformers and tri-annually for some.

1 install an online molecular sieve dry-out system (which circulates and dries the transformer oil without
2 requiring an equipment outage) or perform a hot oil dry out (which circulates and dries the transformer
3 oil and requires an equipment outage).

4 **Oil Leaks and Corrosion**

5 Transformer oil leaks are an environmental hazard and as oil is part of the insulation system, unchecked
6 leaks can affect the safe and reliable operation of a transformer. Leaks can be caused by a number of
7 factors, including failed gaskets or severely corroded radiators, tank piping, and other steel components.
8 Transformers are visually inspected for leaks as part of the regularly scheduled terminal station
9 inspection program and assessed by asset management personnel to determine the level of corrective
10 action. Minor action such as small repairs, patching, and minor painting is undertaken as part of the
11 maintenance. Work requiring major refurbishments and replacements such as radiator or bushing
12 replacements, gasket replacements and tank rusting refurbishment is undertaken under this program.

13 **On-Load Tap Changer**

14 On-load tap changer diverter switches, which are externally mounted on the tank, adjust the voltage by
15 changing the electrical connection point of the transformer winding. This involves moving parts, which
16 are subject to wear and damage. Additionally, in older non-vacuum designed diverter switches, arcing
17 occurs during the movement, leading to deterioration of the insulating oil. This wear and deterioration
18 can lead to failure of the tap changer. Oil testing techniques have been developed by professional
19 laboratories which provide assessments of the condition of the parts and oil. Oil samples are obtained
20 annually from each on-load tap changer to perform a tap changer activity signature analysis by the
21 laboratory. This analysis provides a condition assessment of the tap changer oil and components. Hydro
22 typically implements the laboratory's sampling interval recommendations. This ranges from continued
23 or increased annual sampling, planned refurbishment, or immediate removal from service, inspection,
24 and repair. The latter two activities are covered by this project. Another component covered by this
25 project is to correct leaking seals between tap changer diverter switches and the transformer main tank.
26 Currently, Hydro has several transformers that show low levels of combustible gases, such as acetylene,
27 due to gasses migrating from the tap changer diverter switch compartment to the main tank.

1 **Bushings**

2 In addition to the aforementioned leaking bushings, Hydro must also address suspected bushings to
3 have PCB levels not compliant with the latest PCB regulations, as well as bushings with degraded
4 electrical properties.

5 The latest regulations state that all equipment remaining in service beyond 2025 must have a PCB
6 concentration of less than 50 mg/kg. Hydro has approximately 450 sealed bushings that were
7 manufactured prior to 1985 which are suspected to contain PCBs greater than 50 mg/kg. Some sealed
8 bushings have sampling ports to allow sampling; however, Hydro does not sample due to small quantity
9 of oil in bushings and the risk of contamination during sampling. Bushings which are known or suspected
10 of having unacceptable PCB levels are replaced.

11 Hydro performs power factor testing on bushings every six years as part of the transformer preventive
12 maintenance. When power factor results indicate unacceptable electrical degradation, bushings are
13 scheduled for replacement.

14 **Protective Devices and Fans**

15 Protective devices and cooling fans are tested during visual inspections and preventive maintenance,
16 and are replaced when they fail to operate as designed or their condition warrant replacement. In
17 addition, cooling fans are added where additional cooling is required due to increased loads.

18 **Online Oil Analysis**

19 In addition to oil quality, dissolved gas analysis (“DGA”) is performed on oil. DGA analyzes the levels of
20 dissolved gases in oil, which provides insight into the condition of the transformer insulation. The
21 presence of gases can indicate if the transformer has been subjected to fault conditions or overheating,
22 or if there is internal arcing or partial discharge occurring in the windings. The annual oil sample test can
23 only provide an analysis of transformer condition at the time when the sample is taken. In 2015, as part
24 of this program, Hydro began installing online dissolved gas monitoring on generator step-up (“GSU”)
25 transformers, to allow real-time, continuous monitoring of dissolved gases in oil. This continuously
26 monitors the transformer and provides early fault detection. Continuous data is also a useful tool for
27 personnel to use to trend gases to help schedule repairs or replacement prior to in-service failures,
28 improving the overall reliability of the Island Interconnected System. Continuous monitoring enables
29 Hydro to reduce unplanned outages and lessen the probability of equipment in-service failure.

1 This program was extended to non-GSU transformers in 2017, with online DGA being installed on critical
2 power transformers on the Island Interconnected System. The factors used to determine the criticality
3 score were submitted to the Board in a report on the June 2, 2014.⁶ Hydro has identified 49
4 transformers for installation of online DGA devices between 2019 and 2024.

5 **4.1.7 Circuit Breaker Refurbishment and Replacements**

6 The circuit breaker is a critical component of the power system. Located in a terminal station, each
7 circuit breaker performs switching actions to complete, maintain, and interrupt current flow under
8 normal or fault conditions. The reliable operation of circuit breakers through its fast response and
9 complete interruption of current flow is essential for the protection and stability of the power system.
10 The failure of a breaker to operate as designed may affect reliability and safety of the electrical system
11 resulting in failure of other equipment and the occurrence of an outage affecting more end users. Hydro
12 has over 230 terminal station circuit breakers in service with a voltage rating of 46 kV or greater.

13 Currently, Hydro maintains three different types of high-voltage circuit breakers:

- 14 **1)** Air blast circuit breakers use high-pressure air to interrupt currents and will be at least 38 years
15 old at replacement. In the 2016 CBA project Upgrade Circuit Breakers – Various Sites, approval
16 was obtained to replace air blast circuit breakers on an accelerated schedule by the end of 2020.
17 This work is covered under a separate project and is not part of the work outlined in the Asset
18 Management Overview. Hydro has since modified this program and is targeting completion in
19 2023.
- 20 **2)** Oil circuit breakers use oil to interrupt currents and will be at least 36 years old at replacement.
21 In the 2016 CBA project Upgrade Circuit Breakers – Various Sites, approval was obtained for the
22 replacement of ten oil circuit breakers up to 2020 which were not compliant with Environment
23 Canada’s PCB regulations. Hydro has since modified this program and is targeting completion of
24 that scope in 2022. The remaining non-compliant breakers will be replaced before 2025. From
25 2017, any replacements not previously approved in the 2016 CBA will be included in the work
26 conducted under this section of the Asset Management Overview.

⁶ “Report to the Board of Commissioners of Public Utilities Regarding Work to be Performed on Transformers,” Newfoundland and Labrador Hydro, July 2, 2014.

- 1 **3)** Sulphur hexafluoride (“SF₆”) circuit breakers use SF₆ gas to interrupt current and installation of
2 these breakers started in 1979 and continue for all new installations.



Figure 9: Air Blast Circuit Breakers (Left), SF₆ Circuit Breakers (Middle), and Oil Circuit Breakers (Right)

3 As presented in the 2016 CBA project Upgrade Circuit Breakers – Various Sites, SF₆ circuit breakers rated
4 at 138 kV and above are required to be refurbished after 20 years of service. In 2018, Hydro added 66
5 kV-rated breakers to also be refurbished after 20 years. Replacement of SF₆ circuit breakers rated at 66
6 kV and above will be planned after 40 years of service. However as SF₆ circuit breakers come due, a
7 further condition assessment will be completed to determine if more life can be achieved through other
8 means such as an overhaul. Some SF₆ circuit breakers may require replacement before the 40-year
9 service life period based upon their condition and operational history. Hydro expects to replace an
10 average of seven breakers and overhaul three breakers per year for the 5-year period from 2022 to
11 2026.

12 **4.1.8 Station Service Refurbishment and Upgrades**

13 The power required to operate the various terminal station and distribution substation, collectively
14 referred to as “station” equipment and infrastructure, is provided by the station service system. The
15 station service system provides ac⁷ and dc⁸ power to operate the equipment in a station.

16 The ac station service is generally supplied by one or more transformers in the station. Due to their
17 criticality, 230 kV terminal stations have a redundant station service feed, feed either through a
18 redundant transformer tertiary, supplied from Newfoundland Power’s electrical system where available,
19 or by a diesel generator. Common ac station service loads are:

⁷ Alternating current (“ac”).

⁸ Direct current (“dc”).

- 1 • Transformer cooling fans;
- 2 • Anti-condensation heaters;
- 3 • Station lighting;
- 4 • Control building HVAC;⁹
- 5 • Control building lighting;
- 6 • Air compressors; and
- 7 • Battery chargers.

8 The dc station service is supplied by a battery bank which is charged from the ac station service. The dc
9 station service provides power to critical devices in the station and is designed to allow operation of the
10 station in the event of an ac station service failure. Hydro’s dc station service system is a 125 V system in
11 the majority of the stations with some lower voltage stations and telecommunications equipment
12 having 48 V systems. Common dc station service loads are:

- 13 • Circuit breaker trip and close circuits and charging motors;
- 14 • Protection relays;
- 15 • Emergency lighting;
- 16 • Disconnect switch motor operators for local/remote operation; and
- 17 • Telecommunications equipment.

18 As terminal station equipment is replaced, added, or upgraded, the ac and dc station service loads may
19 increase. Upon the installation of new equipment in the terminal station, Hydro carries out a station
20 service study to determine the loading on the station service system. In the event that the new station
21 service loads exceed the design load of the system, upgrades such as cable, circuit breaker panel,
22 splitter, and transfer switch replacements or additions are required. Replacement of station service
23 transformers is not included in this program as they are addressed separately in the CBA, under the
24 Replace Power Transformers project, if required.

⁹ Heating, ventilation, and air conditioning (“HVAC”).

1 **4.1.9 Battery Banks and Chargers**

2 Battery banks and their chargers supply dc power to critical station infrastructure, such as circuit
3 breakers, protection and control relays, disconnect switch motor operators, and telecontrol equipment.
4 Battery banks are designed to provide a minimum of eight hours of auxiliary power to critical
5 infrastructure in the event of a loss of ac station service supply. The majority of Hydro's battery banks
6 consist of lead-acid flooded-cell type batteries whose capacity deteriorates over time. Hydro currently
7 completes discharge testing on criticality A and B battery banks (after 10 years and then every 5 years
8 for flooded cell and every 2 years for valve regulated) and will plan replacements if the battery bank's
9 capacity has fallen to 80% or less of its rated capacity. Also, due to the critical nature of battery banks,
10 flooded cell batteries are replaced after 20 years while valve-regulated lead-acid batteries are replaced
11 after 10 years.



Figure 10: 125 Vdc Terminal Station Battery Bank

12 **4.1.10 Install Breaker Bypass Switches**

13 High-voltage circuit breakers, with their associated protection and control equipment, are used to
14 control the flow of electrical current to ensure safe and reliable operation of the electrical system. When
15 a breaker is removed from service for maintenance, troubleshooting, refurbishment, or replacement, an
16 alternate electrical path must be implemented to avoid customer outages. On radial systems,¹⁰ this
17 alternate path is accomplished using a bypass switch. When closed, the bypass switch allows electricity

¹⁰ A radial system is an electrical network that has only one electrical path between the source and the load.

- 1 to flow around the breaker allowing the breaker to be safely de-energized while maintaining service
- 2 continuity.

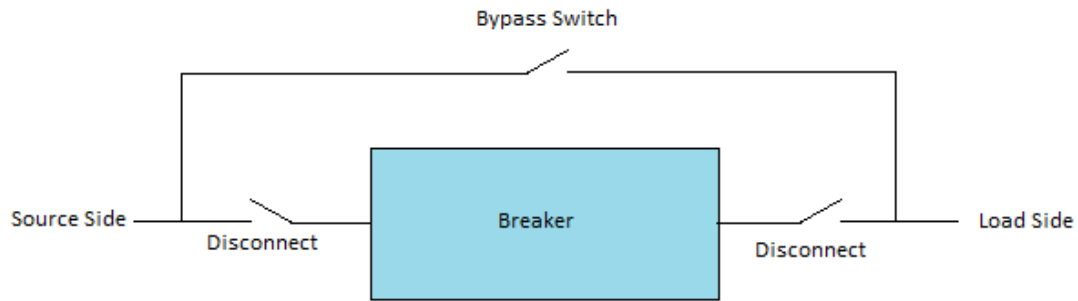

Figure 11: Example of Bypass Switch Installation

- 3 Listed in Table 1 are five radial systems, servicing multiple customers, where breakers are installed
- 4 without bypass switches. In order to ensure service continuity during breaker downtime, Hydro is
- 5 considering installation of breaker bypass as noted in Table 1.

Table 1: Circuit Breakers Without Bypass Switches

Breaker Location	Customers Affected
Bottom Waters L60T1	2,253 Bottom Waters area customers
Buchans B2T1	665 Buchans area Newfoundland Power customers and Duck Pond Mine
Howley B1T2	773 Hampden and Jackson's Arm area customers and 665 Newfoundland Power Howley area customers
Peter's Barren B1L41	1,900 Great Northern Peninsula customers north of Daniel's Harbor
South Brook L22T1	2,340 South Brook area customers.

- 6 Hydro put a hold on this program in 2018 and is looking closer at only doing this work when other major
- 7 terminal station work is planned or if there is a low-cost solution. Doyles B1L15 had a low-cost bypass
- 8 installed in the first quarter of 2020 through an in-service failure project to facilitate the topping up of
- 9 an ongoing leak in breaker B1L15.

1 **4.1.11 Replace Station Lighting**

2 Terminal station lighting is essential to provide adequate illumination for a safe working environment, as
3 well as for deterring theft and vandalism in terminal stations. Hydro utilizes a variety of lighting
4 technologies and configurations, depending on the application and vintage of the lighting system. Over
5 time, exposure to the elements can cause physical deterioration, such as corrosion, leading to moisture
6 ingress which impacts the function of the lighting system. Additionally, some legacy lighting
7 technologies have become obsolete.

8 Under this program, Hydro will replace deteriorated lighting systems as they become unable to provide
9 adequate illumination of the terminal station and have become obsolete or beyond repair. Hydro will
10 replace legacy lighting systems with modern, efficient lighting technologies whenever possible.



Figure 12: Corroded Ballast Requiring Replacement



Figure 13: Light Fixture Showing Perforations due to Corrosion, Enabling Moisture Ingress

1 **4.1.12 Synchronous Condensers**

2 Hydro maintains two synchronous condensers located at Wabush Terminal Station. Each condenser
3 undergoes major and minor inspections on a three-year rotating cycle with minor inspections performed
4 on both year one and year two of the cycle, and a major inspection performed on year three. Each
5 involves a standard list of checks, tests, and general maintenance as well as any additional items that
6 have been identified for follow-up based on the results of previous inspections.

7 The minor inspections involve function testing, vibrations checks, lube oil system maintenance and oil
8 sampling, disassembly and inspection of top half of bearings, clearance checks, electrical tests, visual
9 inspections, as well as cleaning and general maintenance including replacement of various gaskets,
10 filters and hardware.

11 The major inspections expand on the same activities performed under the minor inspections by also
12 rotor and stator inspection, disassembly and inspection of the bottom half of the bearings, and
13 replacement of the thrust bearings.

14 **4.2 Civil Works and Buildings**

15 **4.2.1 Equipment Foundations**

16 Reinforced concrete foundations support high-voltage equipment and structures in Hydro's terminal
17 stations. The majority of these structures formed part of the original station construction and support
18 critical terminal station equipment and buswork.

- 1 The service life of galvanized steel structures varies depending on the operating environment but can
- 2 exceed 100 years outliving the foundations on which they are built. A number of the foundations in
- 3 Hydro terminal stations have deteriorated significantly due to repeated exposure to damaging
- 4 freeze/thaw cycles, weathering, and age, leading to concerns over their integrity. Examples of degraded
- 5 structure foundations are shown in Figure 14 and Figure 15



Figure 14: Structure B1T1 Bottom Brook Terminal Station



Figure 15: Structure L01L37-1 Western Avalon Terminal Station

1 To ensure foundations perform as per the original design intent, severely deteriorated concrete
2 foundations must be refurbished or replaced. Failure to complete repairs could result in a catastrophic
3 failure, causing outages or personal injury. Hydro has carried out engineering inspections of all 230 kV
4 stations and identified foundations requiring repairs. Additionally, Hydro performs visual inspections of
5 foundations every 120 days during regular terminal station inspections. Foundations identified for repair
6 are addressed under this program.

7 **4.2.2 Fire Protection**

8 Hydro's terminal station control buildings contain combustible materials. As these facilities are
9 unattended, a fire could spread causing severe damage to protection and control wiring and equipment
10 which would cause extended and widespread outages. Restoration of a terminal station severely
11 damaged by fire to normal operation could take months.

12 Hydro is installing fire suppression systems in its 230 kV terminal stations to protect the control cabinets
13 and cables and any other critical equipment from being destroyed by a fire without damaging sensitive
14 electronic equipment and wiring.

1 In the 2015 and 2016 CBA Install Fire Protection projects, Hydro received approval to install fire
2 protection in the Holyrood and Bay d’Espoir Terminal Stations. Due to their criticality, Hydro intends to
3 continue its program to install fire suppression systems in all 230 kV terminal stations.

4 **4.2.3 Control Buildings**

5 Terminal station control buildings contain critical station infrastructure such as protection, control, and
6 monitoring equipment; telecontrol equipment; station service equipment; and compressed air systems.
7 Many control buildings also contain office, breakroom, and washroom facilities for use by Hydro crews
8 when working in the station. As the equipment in control buildings is critical to the function of the
9 terminal station, it is imperative that Hydro ensures the structural integrity, weather tightness, and
10 security of its control buildings. While addressing these issues, Hydro also ensures that building
11 auxiliaries such as electrical, plumbing, and HVAC systems function properly to ensure reliable and safe
12 operation and use of the terminal station and the control building.

13 Typical refurbishment activities for control building involve replacement of the roof membrane (Figure
14 16), siding, and doors (Figure 17), and may also include replacement of electrical equipment (such as
15 distribution panels, transfer switches, or low-voltage disconnects), plumbing (such as water service
16 entries and internal plumbing), and HVAC (such as intake and exhaust fans, louvers, heaters, and air
17 conditioning equipment).

18 In its 2016 CBA, Hydro submitted its “Upgrade Office Facilities and Control Buildings Condition
19 Assessment and Refurbishment Program Asset Management Strategy Plan,”¹¹ which outlined Hydro’s
20 approach to address aging and failing building infrastructure. Hydro will undertake the refurbishment of
21 control buildings under the Project.

¹¹ “2016 Capital Budget Application,” Newfoundland and Labrador Hydro, July 31, 2015, vol. III, tab 23.



Figure 16: Terminal Station Control Buildings (Come by Chance and Sunnyside) Showing Cracking and Deterioration of the Roof Membrane System



Figure 17: Building Exterior Cladding and Exterior Doorways Displaying Severe Rusting and Deterioration

1 **4.3 Protection, Control, and Monitoring**

2 **4.3.1 Protection and Control Upgrades and Refurbishment**

3 The terminal station protection and control system automatically monitors, analyzes, and causes action
4 by other equipment, such as breakers, to ensure the safe, reliable operation of the electrical system or

1 to initiate action when a command is issued by system operators. The protection and control system
2 also provides indications of system conditions and alarms and allows the recording of system conditions
3 for analysis. Hydro carries out capital work on various protection and control equipment, including:

- 4 • Protective relays;
- 5 • Breaker failure protection;
- 6 • Circuit breaker reclosing controllers;
- 7 • Tap changer controls;
- 8 • Data alarm systems;
- 9 • Digital fault recorders; and
- 10 • Cables and panels.

11 **Electromechanical and Solid State Protective Relay Replacement**

12 Protective relays monitor and analyze the operation conditions of the electrical system. When a relay
13 identifies unacceptable operating conditions, such as a fault, it will initiate an action to isolate the
14 source of the condition by commanding high-voltage equipment such as breakers to operate. Protective
15 relays play a crucial role in maintaining system stability and preventing hazardous conditions from
16 damaging electrical equipment or harming personnel.

17 Older relays existing on Hydro's system are the electromechanical and older solid state types and lack
18 features such as data storage and event recording capability. Modern digital multifunction relays are
19 used to replace these older style relays as they have increased setting flexibility, fault disturbance
20 monitoring, communications capability and metering functionality, and offer greater dependability and
21 security, enhancing system reliability. Digital and electromechanical relays are showing in Figure 18.

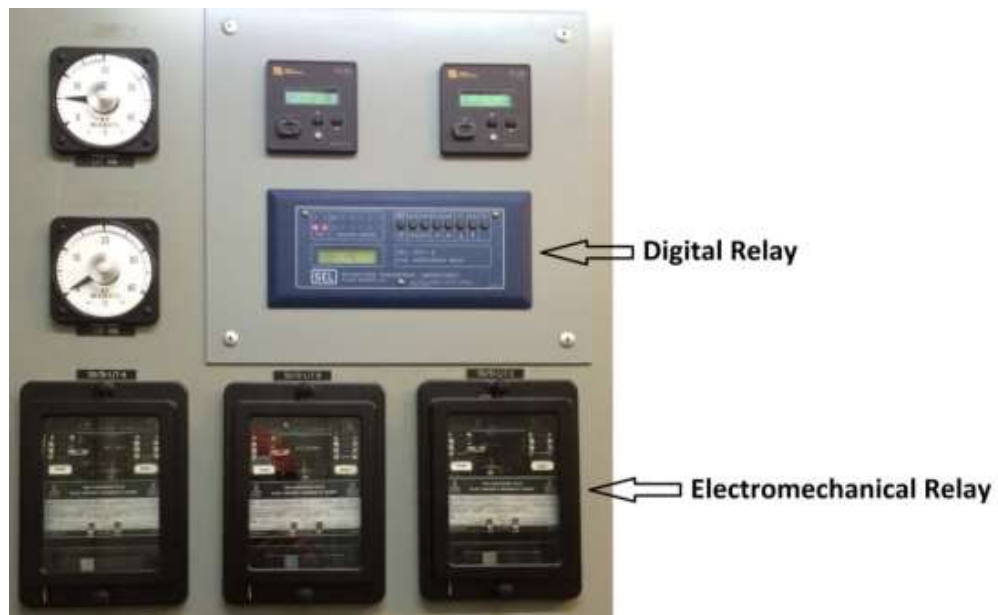

Figure 18: Digital and Electromechanical Relays

1 In its report dated August 1, 2014,¹² Hydro stated it “. . . plans to review its existing transformer, bus,
2 and line protections in an effort to develop plans for future implementation of modern digital relays
3 with data storage and fault recording capabilities.” To fulfill this commitment, Hydro completed the
4 following:

- 5 • A review of all transformer, bus, and line protection on 230 kV, 138 kV, and 69 kV systems,
6 including data storage and fault recording capabilities; and
- 7 • A plan to replace all existing electromechanical transformer, bus, timer, and line protection
8 relays with modern digital relays. The 230 kV relays are the priority for the first phase of the
9 plan, with 138 kV and 69 kV to follow.

10 As part of the annual Terminal Station Refurbishment and Modernization project, Hydro will continue to
11 execute the replacement of 230 kV electromechanical and obsolete solid-state transformer, line, and
12 bus relays with modern digital multifunction relays, which began in 2016 under the Replace Protective
13 Relays Program. Additionally, in line with Hydro’s response to CA-NLH-037 as part of the 2016 CBA,

¹² “Report to the Board of Commissioners of Public Utilities Related to Alarms, Event Recording Devices, and Digital Relays,” Newfoundland and Labrador Hydro, August 1, 2014, at s. 3.1

1 Hydro installed redundant multifunction transformer protection relays in 2016 for transformers rated
2 above 10 MVA. Under this program Hydro will continue to install these upgrades.

3 Furthermore, in 2021 as part of the annual Terminal Station Refurbishment and Modernization project,
4 Hydro has begun the replacement of protection relays in the Wabush Terminal Station on 46kV feeders.
5 Each replacement is currently planned to coincide with the replacement of the circuit breaker
6 associated with that protection.

7 **Breaker Failure Protection**

8 Protective relaying is designed to trip a breaker during fault conditions to remove the fault from the
9 electrical system so as to minimize equipment outages and maintain system stability and safe, reliable
10 operation. When a breaker does not properly isolate a fault, other breakers will be commanded to trip
11 to isolate the fault. This will result in larger outages but will ensure isolation of the original fault in a time
12 to minimize damage to equipment and minimize impact to the system. The failure of a breaker to isolate
13 a fault when commanded is called a breaker failure.

14 Prior to 2014, breaker failure protection was implemented only in Hydro's 230 kV terminal stations. In
15 2014, Hydro completed a review of breaker failure protection in 66 kV and 138 kV terminal stations.
16 Hydro also developed a protection and control standard, Application of Breaker Failure Relaying, calling
17 for breaker failure protection on transmission breakers rated at 66 kV and above. From this review,
18 Hydro identified 20 terminal stations requiring breaker failure protection.

19 As part of Hydro's 2016 CBA, Hydro proposed and received Board approval for the installation of breaker
20 failure protection in three terminal stations.¹³ As part of the annual Terminal Station Refurbishment and
21 Modernization project, Hydro will continue its plan to execute the installation of breaker failure
22 protection in the remaining terminal stations. As well, Hydro has identified concerns with the reliability
23 of legacy breaker failure in 230 kV stations and will be replacing as necessary under this program.

24 **Tap Changer Paralleling Control Replacement**

25 Tap changer paralleling controls are designed to:

- 26 • Ensure the load bus voltage is regulated as prescribed by the setting;

¹³ *Public Utilities Act*, Board Order No. P.U. 33(2015), Board of Commissioners of Public Utilities, December 2, 2015.

- 1 • Minimize the current that circulates between the transformers, as would be due to the tap
- 2 changers operating on inappropriate tap positions; and
- 3 • Ensure the controller operates correctly in multiple transformer applications regardless of
- 4 system configuration changes or station breaker operations and resultant station configuration
- 5 changes.

6 Current tap changer controls are of similar vintage as the power transformers dating back to the late
7 1960s and require replacement. Recent feedback from the tap changer paralleling control supplier
8 indicated older equipment has capacitors that will dry out over time resulting in control issues.
9 Additionally, it was recommended the same controller model be applied to all transformers to optimize
10 tap changing control. The control issues as described by the supplier have been seen by Hydro staff at
11 numerous sites.

12 Hydro started replacing tap changer paralleling controls in 2019 beginning at the Western Avalon
13 Terminal Station.

14 **Equipment Alarm Upgrades**

15 Alarms inform the Energy Control Centre (“ECC”) and operating personnel that equipment and relaying
16 requires attention and are communicated to the ECC and/or displayed locally on the station
17 annunciator.



Figure 19: Annunciator Commonly Found in Hydro Terminal Stations

1 Hydro’s review of alarms, event recording devices, and digital relays found that by providing more
2 detailed alarm schemes, the ECC and local operators are able to troubleshoot system events more
3 accurately and quickly.

4 Hydro’s internal study identified required increases to alarm detail to the ECC for five 230 kV terminal
5 stations. Stony Brook, Holyrood, Sunnyside, Oxen Pond, and Massey Drive Terminal Stations were
6 assessed. Hydro proposed and received approval to implement the proposed upgrades at the Stony
7 Brook terminal station as part of the 2016 CBA project Upgrade Data Alarm Systems – Stony Brook.¹⁴
8 Hydro will continue its plan to install improved data alarm management as part of the Terminal Station
9 Refurbishment and Modernization project, with the remaining stations being addressed in future CBAs.

10 **Digital Fault Recorders**

11 Digital fault recorders record analog electrical data, such as voltage, frequency, and current as well as
12 digital relay contact positions, at a high resolution to allow Hydro to determine the cause and location of
13 an electrical fault. This data allows Hydro to restore service in a timely manner, address system
14 configurations and settings to mitigate the impact of future faults, and improve the protection of critical

¹⁴ “2016 Capital Budget Application,” Newfoundland and Labrador Hydro, July 31, 2015, vol. I, sec. D.

1 electrical infrastructure. Hydro has digital fault recorders deployed in several stations and has a program
2 to install digital fault recorders in areas where Hydro does not have sufficient coverage to allow the
3 analysis of faults.

4 **Protection and Control Cable and Panel Modifications**

5 This program will cover protection and control panels and wiring that may require alteration,
6 replacement, or addition to existing wiring due to deterioration from environment conditions,
7 accidental damage or the modification/addition of protection and control equipment.